

SIG SAUER[®]
when it counts[®]



P320[®]

P320 X-Series

OPERATORS MANUAL: HANDLING & SAFETY INSTRUCTIONS



**READ THE INSTRUCTIONS AND WARNINGS IN THIS MANUAL CAREFULLY
BEFORE USING THIS FIREARM; DO NOT DISCARD THIS MANUAL.**

This instruction manual should always accompany this firearm and be transferred with it upon ownership, or when the firearm is loaned or presented to another person.

1.0 SAFETY WARNINGS – Read this entire manual thoroughly and carefully prior to using this SIG SAUER firearm.

The warnings in this operator's manual are important. By understanding the dangers inherent in the use of any firearm, and by taking the precautions described in this manual, you can experience a higher level of safety in the use of your firearm. Failure to heed any of these warnings may result in serious injury or death to you or others, as well as severe damage to the firearm or other property.

As a valued SIG SAUER customer we encourage you to visit www.sigsauer.com. There you will find links to product information and updates, merchandise promotions, and educational videos that will be of interest to you as an owner of SIG SAUER products.

SIG SAUER firearms are designed to function reliably with proper care and knowledgeable use. You must understand the safe operation and use of your SIG SAUER firearm. Read and follow these directions carefully. Do not use the firearm unless you fully understand these instructions and the safe operation of your firearm. Failure to heed any of these directions may result in serious injury or death to you or others, as well as severe damage to the firearm or other property.

Your firearm comes equipped with effective, well-designed safety features. However, never rely completely on any safety mechanism. Safety mechanisms are designed to augment, not replace safe handling practices. Careless and improper handling of any firearm can result in an unintentional discharge. Many safeties are incorporated into your firearm. Only your safe firearm handling habits will ensure the safe use of your firearm. Like all mechanical devices, the safety is subject to breakage or malfunction and can be adversely affected by wear, abuse, dirt, corrosion, incorrect assembly, improper adjustment or repair, or lack of maintenance. Moreover, there is no such thing as a safety that is "childproof" or that can completely prevent accidental discharge from improper usage, carelessness, or "horseplay".

The best safety is proper and applied training in safe firearms handling. Always handle your firearm as though you expect the safeties not to work.

Do not load a round into the chamber until you are ready to use the pistol. If your firearm is equipped with a manual safety, keep the safety **ON** and your finger off the trigger until you are ready to fire. Always move the safety to its intended position and visually check it. The safety is not **ON** unless it is completely **ON**.

ABUSIVE HANDLING

All SIG SAUER firearms incorporate effective mechanical safeties. However, like any mechanical device, exposure to abusive conditions may have a negative effect on these safety mechanisms and cause them to fail to work as designed.

Do not subject your SIG SAUER firearm to any type of abusive handling. This includes the firearm being dropped, impact to the firearm, or the firearm being struck by another object.

Make sure you always maintain control of your firearm at all times. If your firearm does suffer an abusive event, as previously described, do not attempt to use the firearm. Keep the firearm pointed in a safe direction, unload and clear the firearm immediately, and have it inspected by a certified SIG SAUER Armorer or gunsmith prior to using the firearm.

A safe direction is defined as an area in which, if the firearm were to discharge, no property damage would occur and no personal injury would result.

As previously noted, if your SIG SAUER firearm does suffer an abusive event, unload it immediately and have it inspected by a certified SIG SAUER Armorer or gunsmith prior to using the firearm. If your firearm suffers an abusive event during a life threatening / self-defense situation, you must apply immediate action by:

1. Pulling the slide completely rearward to eject the chambered cartridge.
2. Release the slide to chamber a new cartridge and reset the trigger mechanism. (Do not ride the slide forward)

WARNING

3. The firearm is now returned to proper operational condition.

Intentional or repetitive abusive handling of any SIG SAUER firearm will void the manufacturer's warranty and could render the firearm unsafe.

REPLACEMENT PARTS

Do not attempt to disassemble your SIG SAUER firearm beyond the point explained in this manual. Disassembly beyond the instructions in this manual is restricted to a certified SIG SAUER Armorer or Professional Gunsmith. Failure to comply with these restrictions will void your warranty.

Warnings and instructions about the use of some SIG SAUER replacement parts, assemblies, and accessories may be described in literature accompanying the specific products. Read and carefully follow those instructions. Such warnings and instructions are provided to assure the safe functioning of the firearm. Failure to heed them may result in improper functioning, damage to the firearm, and serious injury or death.

ALTERATIONS

This SIG SAUER firearm was designed to function properly in its original condition. Unauthorized alterations can make it unsafe. Do not alter any part or add or substitute any parts or accessories not manufactured by SIG SAUER for this pistol. The addition of any parts or accessories beyond the user level of maintenance described in this manual are not authorized.

PROTECT YOUR EYES AND EARS

Always wear eye protection that meets the requirements of American National Standards Institute (ANSI) Z87.1 and ear plugs or " earmuff " type hearing protectors whenever you are shooting. Always make certain that persons close to you are

similarly protected. Unprotected eyes may be injured by powder, gas, carbon residue, lubricant, metallic particles, or similar debris that may emanate occasionally from any firearm in normal use. Without proper hearing protection, repeated exposure to shooting noise may lead to cumulative, permanent hearing loss.

ACCESSORIES

It is your responsibility to ensure all accessories, such as holsters and firearm mounted lights are compatible with this firearm and that the accessories do not interfere with the safe operation and handling of the firearm. If you are lawfully carrying the firearm concealed, you must ensure that the holster you choose is made for your particular firearm and designed for the type of carry in which you intend to engage.

TRANSPORTING

When transporting your firearm, be sure the firearm is unloaded and cleared. It is your responsibility to familiarize yourself with the laws of any state you will be travelling through with your firearm.

STORAGE

Certain states require that specific regulations be printed in the operator manuals. Those state-by-state regulations and warnings are listed in the State-By-State Warnings section of this manual.

The only safe way to store your firearm is unloaded, cleared, and secure. Safe and secure storage is one of your most important responsibilities. Store your unloaded firearm separate from your ammunition and in places inaccessible to children and unauthorized persons.

⚠ WARNING

WARNINGS OF GREAT IMPORTANCE ARE FOUND WITHIN THIS MANUAL

Alterations	6	Maintenance	38, 48
Safety	7	Disassembly	39, 41, 55
Protect Eyes and Ears	7	Cleaning	42
Locking Devices	12	Lubrication	42
Ammunition	18, 21	Assembly	45, 47
Lodged Bullet	20	Inspection	51
Lead Exposure	21	Alterations	57
Loaded Pistol	25, 27	Tritium Sights	58
Trigger	28	Sight Adjustment	59, 60
Stoppage	28	Storage	62
Ejection	29	Parts Purchasers	63
Unloading	31, 34, 52	Shipping	66
Stoppage	35, 37		

OTHER CAUTIONS AND WARNINGS APPEAR THROUGHOUT THE MANUAL

FIREARMS ARE DANGEROUS WEAPONS

**READ THE INSTRUCTIONS AND WARNINGS IN
THIS MANUAL THOROUGHLY AND CAREFULLY
BEFORE USING.**

⚠ WARNING – ALTERATIONS



This product was designed to function properly in its original condition. Alterations can make it unsafe. Do not alter any part or add or substitute any parts or accessories not manufactured by SIG SAUER for this pistol.

DO NOT ALTER ANY FIREARM

SAFETY WARNINGS

The safety warnings in this manual are extremely important. By understanding the dangers inherent in the use of any firearm, and by taking the precautions described herein, you can experience a higher level of safety in the use of your pistol. Failure to heed any of these warnings may result in serious injury to you or others, as well as severe damage to the firearm or other property.

PISTOLS are classified as FIREARMS and are sold by SIG SAUER with the specific understanding that we shall not be responsible in any manner whatsoever for malfunctioning of the firearm, physical injury or property damage resulting in whole or in part from:

- criminal or negligent discharge
- improper, careless, or abusive handling
- unauthorized modifications or parts replacement
- defective, improper, hand-loaded, or reloaded ammunition
- corrosion
- neglect
- other influences beyond our direct and immediate control.

This limitation applies regardless of whether liability is asserted on the basis of contract, negligence, or strict liability (including any failure to warn). Under no circumstance shall SIG SAUER, Inc. be liable for incidental or consequential damages, such as loss of use of property, commercial loss, and loss of earnings or profits.

! WARNING – PROTECT YOUR EYES AND EARS



Always wear safety glasses that meet the requirements of American National Standards Institute (ANSI) Z87.1 and ear plugs or “ earmuff ” type protectors whenever you are shooting. Always make certain that persons close to you are similarly protected. Unprotected eyes may be injured by powder, gas, carbon residue, lubricant, metallic particles, or similar debris that may emanate

occasionally from any firearm in normal use. Without ear protection, repeated exposure to shooting noise may lead to cumulative, permanent hearing loss.

THE BASIC RULES OF SAFE FIREARMS HANDLING

1. ALWAYS treat every firearm as if it were loaded.
2. ALWAYS be sure the barrel is clear of any obstruction.
3. ALWAYS be sure of your backstop, what lies beyond, and the safety of bystanders before you shoot.
4. ALWAYS use clean, dry, original factory-made ammunition of the proper type and caliber for your firearm.
5. ALWAYS wear ear protection and safety glasses when shooting.
6. ALWAYS carry your firearm so that you can control the direction of the muzzle if you fall or stumble.
7. NEVER shoot at a flat surface or water.
8. DO NOT leave an unattended firearm loaded. Firearms and ammunition should be stored separately, locked if possible, beyond the reach of children, careless adults, and unauthorized users.
9. NEVER allow your firearm to be used by anyone who has not read and understood this operator's manual.
10. DO NOT point any firearm, loaded or unloaded, at any undesired target.
11. NEVER fire your firearm near an animal unless it is trained to accept the noise: an animal's startled reaction could injure it or cause an accident.
12. NEVER drink alcoholic beverages or take drugs before or during shooting, as your vision and judgment could be seriously impaired, making your firearm handling unsafe.

State-By-State Warnings

Certain states require, by law, that their own specified warning notices, in larger-than-normal type be conspicuously included by the manufacturer, distributor, or retail dealer with firearms sold in that state. SIG SAUER sells its products in compliance with applicable laws and regulations. Because our products may be sold in these states, we include the following:

CALIFORNIA: WARNING

"Children are attracted to and can operate firearms that can cause severe injuries or death. Prevent child access by always keeping guns locked away and unloaded when not in use. If you keep a loaded firearm where a child obtains and improperly uses it, you may be fined or sent to prison."

ADVERTENCIA

"A los niños atraen las armas de fuego y las pueden hacer funcionar. Ellos pueden causarse lesiones graves y la muerte. Evite que los niños tengan acceso a las armas de fuego guardándolas siempre con llave y descargadas cuando no las esté utilizando. Si usted tiene una arma de fuego cargada en un lugar en que un niño tiene acceso a ella y la usa indebidamente, le pueden dar una multa o enviarlo a la cárcel."

CONNECTICUT:

"UNLAWFUL STORAGE OF A LOADED FIREARM MAY RESULT IN IMPRISONMENT OR FINE."

FLORIDA:

"IT IS UNLAWFUL, AND PUNISHABLE BY IMPRISONMENT AND FINE, FOR ANY ADULT TO STORE OR LEAVE A FIREARM IN ANY PLACE WITHIN THE REACH OR EASY ACCESS OF A MINOR UNDER 18 YEARS OF AGE OR TO KNOWINGLY SELL OR OTHERWISE TRANSFER OWNERSHIP OR POSSESSION OF A FIREARM TO A MINOR OR A PERSON OF UNSOUND MIND."

MAINE:

"ENDANGERING THE WELFARE OF A CHILD IS A CRIME. IF YOU LEAVE A FIREARM AND AMMUNITION WITHIN EASY ACCESS OF A CHILD, YOU MAY BE SUBJECT TO FINE, IMPRISONMENT OR BOTH. KEEP FIREARMS AND AMMUNITION SEPARATE. KEEP FIREARMS AND AMMUNITION LOCKED UP. USE TRIGGER LOCKS."

MARYLAND:

"WARNING: Children can operate firearms which may cause death or serious injury. It is a crime to store or leave a loaded firearm in any location where an individual knew or should have known that an unsupervised minor would gain access to the firearm. Store your firearm responsibly!"

MASSACHUSETTS:

"WARNING FROM THE MASSACHUSETTS ATTORNEY GENERAL: This handgun is not equipped with a device that fully blocks use by unauthorized users. More than 200,000 firearms like this one are stolen from their owners every year in the United States. In addition, there are more than a thousand suicides each year by younger children and teenagers who get access to firearms. Hundreds more die from accidental discharge. It is likely that many more children sustain serious wounds, or inflict such wounds accidentally on others. In order to limit the chance of such misuse, it is imperative that you keep this weapon locked in a secure place and take other steps necessary to limit the possibility of theft or accident. Failure to take reasonable preventative steps may result in innocent lives being lost, and in some circumstances may result in your liability for these deaths."

"IT IS UNLAWFUL TO STORE OR KEEP A FIREARM, RIFLE, SHOTGUN OR MACHINE GUN IN ANY PLACE UNLESS THAT WEAPON IS EQUIPPED WITH A TAMPER RESISTANT SAFETY DEVICE OR IS STORED OR KEPT IN A SECURELY LOCKED CONTAINER."

NEW JERSEY:

"IT IS A CRIMINAL OFFENSE TO LEAVE A LOADED FIREARM WITHIN EASY ACCESS OF A MINOR."

NEW YORK CITY, NY:

"THE USE OF A LOCKING DEVICE OR SAFETY LOCK IS ONLY ONE ASPECT OF RESPONSIBLE FIREARMS STORAGE. FOR INCREASED SAFETY, FIREARMS SHOULD BE STORED UNLOADED AND LOCKED IN A LOCATION THAT IS BOTH SEPARATE FROM THEIR AMMUNITION AND INACCESSIBLE TO CHILDREN AND OTHER UNAUTHORIZED PERSONS."

NORTH CAROLINA:

Any person who resides in the same premises as a minor, owns or possesses a firearm, and stores or leaves the firearm (i) in a condition that the firearm can be discharged and (ii) in a manner that the person knew or should have known that an unsupervised minor would be able to gain access to the firearm, is guilty of a Class 1 misdemeanor if a minor gains access to the firearm without the lawful permission of the minor's parents or a person having charge of the minor and the minor:

- (1) Possesses it in violation of G.S. 14-269.2(b)
- (2) Exhibits it in a public place in a careless, angry, or threatening manner;
- (3) Causes personal injury or death with it not in self defense; or
- (4) Uses it in the commission of a crime.

TEXAS:

"IT IS UNLAWFUL TO STORE, TRANSPORT, OR ABANDON AN UNSECURED FIREARM IN A PLACE WHERE CHILDREN ARE LIKELY TO BE AND CAN OBTAIN ACCESS TO THE FIREARM."

WISCONSIN:

"IF YOU LEAVE A LOADED FIREARM WITHIN THE REACH OR EASY ACCESS OF A CHILD YOU MAY BE FINED OR IMPRISONED OR BOTH IF THE CHILD IMPROPERLY DISCHARGES, POSSESSES, OR EXHIBITS THE FIREARM."

Please check with your licensed retailer, state police, or local police for additional warnings, which may be required by local law or regulation. Such regulations change constantly, and local authorities are in the best position to advise you on such legal matters.

WARNING

WARNING – LOCKING DEVICES



This firearm was originally sold with a key-operated locking device. While it can help provide secure storage for your unloaded firearm, any locking device can fail. All firearms are designed to fire if they are loaded and the trigger is pressed. Therefore, never install the locking device inside the trigger guard or in any way that makes it possible to press the trigger! Do not leave the keys in the lock.

The ultimate responsibility for secure storage of any firearm must depend upon its owner and his or her individual circumstances. Firearms should be stored unloaded, in a secure location, separate from their ammunition.



**NEVER INSTALL THE
LOCKING DEVICE INSIDE
THE TRIGGER GUARD**

To maximize effectiveness and reduce the chances of malfunction or damage to a firearm, ALWAYS refer to the locking device's manufacturer directions for installation and removal of the device.

FIREARMS SAFETY IS YOUR RESPONSIBILITY

This operator's manual is designed to assist you in learning how to use and care for your SIG SAUER® pistol properly.

Only when you are certain that you fully understand this manual and can properly carry out its instructions, should you practice loading and firing your firearm with live ammunition. Having a firearm in your possession is a full-time job; you cannot guess and you cannot forget. You must know how to use your firearm safely.

If you have any doubts about your ability to handle or use this firearm safely, you should seek supervised instruction. The SIG SAUER AcademySM provides all levels of firearms safety and skill training, from beginner to expert.

For more information contact:



www.sigsaueracademy.com • (603) 610-3400

Epping, New Hampshire

SAFETY MUST BE THE FIRST AND CONSTANT CONSIDERATION OF EVERY PERSON WHO HANDLES FIREARMS AND AMMUNITION.

For more information about safety, responsible firearms ownership, and shooting sports, contact:

National Rifle Association (NRA) of America
11250 Waples Mill Road, Fairfax, VA 22030-7400 • 1-800-672-3888
www.nra.com

TABLE OF CONTENTS

Topic	Page
1.0 Safety Warnings	2
Warnings of Great Importance	6
The Basic Rules of Safe Firearms Handling	8
State-By-State Warnings	9
Locking Devices	12
2.0 Mechanical Characteristics and Theory of Operation	16
2.1 Description of Firearm	16
2.1.1 General	16
2.1.2 Principal Features	16
2.2 Main Components and Operator Controls	17
3.0 Ammunition	18
4.0 Handling	22
4.1 Preparation Instructions	22
4.2 Manual Safety Equipped Pistols	22
4.3 Magwell Equipped Pistols	23
4.4 Loading the Magazine	24
4.5 Loading the Pistol (Ready to Fire)	24
4.6 Reloading During Shooting	26
5.0 Firing	28
5.1 Clearing a Stoppage	28
5.2 Firing the Pistol	30
6.0 Unloading the Pistol	31
6.1 Unloading the Pistol (Magazine Not Empty)	32
6.2 Unloading the Pistol (Magazine Empty, Slide Open)	33
7.0 Procedures in Case of a Stoppage	35
7.1 Troubleshooting Guide	36
7.2 Minimize Stoppages	37
8.0 Maintenance	38
8.1 Pistol Disassembly	38
8.2 Magazine Disassembly	40

Topic	Page
8.3 Cleaning the P320 Pistol	42
8.4 Pistol Assembly	45
8.5 Magazine Assembly	47
8.6 Function Verification	48
9.0 Pistol Adjustments	52
9.1 General Information	52
9.2 Magazine Catch Removal and Reversal	53
9.3 Changing the Grip Module	54
9.3.1 Disassembly	54
9.3.2 Assembly	56
10.0 Sights	58
10.1 General Information	59
10.2 Windage Adjustment	59
10.3 Elevation Adjustment	60
10.4 Sight Adjustment X-Series	61
11.0 Transportation and Storage	62
12.0 Service and Parts Policy	63
12.1 Parts Policy	63
12.2 Service Policy	64
12.3 Shipping Firearms for Repair	64
12.4 Ordering Parts	66
13.0 Standard Slide Parts Diagram	67
13.1 X-FIVE Parts Diagram	68
13.2 X-VTAC Parts Diagram	69
13.3 X-CARRY Parts Diagram	70
13.4 Standard Frame Parts Diagram	71
13.5 X-Series Frame Parts Diagram	72
14.0 Technical Specifications	73
14.1 Full Size Specifications	74
14.2 Compact Specifications	75
14.3 Subcompact Specifications	76
14.4 Carry Specifications	77
14.5 X-Series Specifications	78
Warranty Information	79

2.0 Mechanical Characteristics and Theory of Operation

2.1 Description of Firearm

2.1.1. General

The SIG SAUER P320 pistol is a modern handgun incorporating the latest technical advances in weapon design for military, law enforcement and sporting use. The P320 is a mechanically locked, short recoil operated pistol with semi-automatic reloading. Firing takes place with each press of the trigger until the magazine is empty. The slide remains open after the last round has been fired from the magazine.

2.1.2 Principal Features

The striker safety lock and disconnect safety ensure safe carrying of the weapon and provide instant readiness without actuating a manual safety.

Distinctive high-contrast sights, in conjunction with the ergonomically correct grip, ensure rapid target acquisition and engagement, even under poor lighting conditions.

Interchangeable grip modules of different sizes allow for optimal adaptation of the weapon to the individual user.

The magazine catch can easily be reconfigured for left or right-hand operation. All other operating controls are designed so they can be operated from either side.

A Picatinny rail is integrated into the grip module, facilitating the easy attachment of industry standard tactical accessories.

The closed design of the pistol helps keep dirt and other debris from entering the pistol, reducing the likelihood of malfunction in harsh environmental conditions.

The P320 pistol is a striker-fired design.

The P320 is offered with an optional ambidextrous manual safety.

2.2 Main Components and Operator Controls



1 - Front Sight

2 - Slide

3 - Barrel

4 - Rear Sight

5 - Slide Catch Lever

6 - Magazine Floor Plate

7 - Magazine Catch

8 - Trigger

9 - Takedown Lever

10 - Grip Module

11 - Optional Manual
Safety

Note: Refer to section 13 for a detailed parts list and diagram.

3.0 Ammunition

1. Use only high-quality, original, factory-manufactured ammunition. Do not use cartridges that are dirty, wet, corroded, bent, or damaged. Do not oil cartridges. Do not spray aerosol-type lubricants, preservatives, or cleaners directly onto cartridges or where excess spray may flow into contact with cartridges. Lubricant or other foreign matter on cartridges can cause potentially dangerous ammunition malfunctions. Only use ammunition of the caliber for which your firearm is chambered. The proper caliber is permanently engraved on your firearm; never attempt to use ammunition of any other caliber.

2. The use of reloaded, “remanufactured” hand-loaded, or other non-standard ammunition voids all warranties. Reloading is a science and improperly loaded ammunition can be extremely dangerous. Severe damage to the firearm and serious injury to the shooter or to others may result. Always use ammunition that complies with the industry performance standards established by the Sporting Arms and Ammunition Manufacturers’ Institute, Inc. (SAAMI) or ammunition manufactured to military specifications.

▲ WARNING – AMMUNITION (CARTRIDGE) NOTICE

SIG SAUER SPECIFICALLY DISCLAIMS RESPONSIBILITY FOR ANY DAMAGE OR INJURY WHATSOEVER OCCURRING IN CONNECTION WITH, OR AS A RESULT OF, THE USE IN ANY SIG SAUER FIREARM OF NON-STANDARD, RELOADED, “REMANUFACTURED” HAND-LOADED, OR FAULTY AMMUNITION, OR CARTRIDGES OTHER THAN THOSE FOR WHICH THE FIREARM WAS ORIGINALLY CHAMBERED.

3. Firearms may be severely damaged and serious injury to the shooter or to others may result from any condition causing excessive pressure inside the chamber or barrel during firing. Excessive pressure can be caused by obstructions in the barrel, propellant powder overloads, the use of incorrect cartridges, or defectively assembled cartridges. In addition, the use of a dirty, corroded, or damaged cartridge can lead to a burst cartridge case and consequent damage to the firearm and personal injury from the sudden escape of high-pressure propellant gas within the firearm's mechanism.

4. Immediately stop shooting and check the barrel for a possible obstruction whenever:

- You have difficulty in, or feel unusual resistance in, chambering a cartridge
- A cartridge misfires (does not go off)
- The mechanism fails to extract a fired cartridge case
- Unburned grains of propellant powder are discovered spilled in the mechanism
- A shot sounds weak or abnormal. In such cases it is possible that a bullet is lodged partway down the barrel. Firing a subsequent bullet into the obstructed barrel can wreck the firearm and cause serious injury to the shooter or to bystanders

5. Bullets can become lodged in the barrel:

- If the cartridge has been improperly loaded without propellant powder, or if the powder fails to ignite (ignition of the cartridge primer alone will push the bullet out of the cartridge case, but usually does not generate sufficient energy to expel the bullet completely from the barrel).
- If the bullet is not properly seated in the cartridge case. When such a cartridge is extracted from the chamber without being fired, the bullet may be left behind in the bore at the point where the rifling begins. Subsequent chambering of another cartridge may push the first bullet further into the bore.

6. If there is any reason to suspect that a bullet is obstructing the barrel, immediately unload the firearm and look through the bore. It is not sufficient to merely look in the chamber.

A bullet may be lodged some distance down the barrel where it cannot easily be seen.

⚠ WARNING – LODGED BULLET

IF A BULLET IS IN THE BORE, DO NOT ATTEMPT TO SHOOT IT OUT BY USING ANOTHER CARTRIDGE OR BY BLOWING IT OUT WITH A BLANK OR ONE FROM WHICH THE BULLET HAS BEEN REMOVED. SUCH TECHNIQUES CAN GENERATE EXCESSIVE PRESSURE, DAMAGE THE FIREARM, AND CAUSE SERIOUS PERSONAL INJURY.

If the bullet can be removed with a cleaning rod, clean any unburned powder grains from the bore, chamber, and mechanism before resuming shooting. If the bullet cannot be dislodged by tapping it with a cleaning rod, send the firearm to SIG SAUER.

7. Dirt, corrosion, or other foreign matter on a cartridge can impede complete chambering and may cause the cartridge case to burst upon firing. The same is true of cartridges that are damaged or deformed.

8. Do not oil cartridges, and be sure to wipe the chamber clean of any oil or preservative before commencing to shoot. Oil interferes with the friction between cartridge case and chamber wall that is necessary for safe functioning, and subjects the firearm to stress similar to that imposed by excessive pressure.

9. Use lubricants sparingly on the moving parts of your firearm. Avoid excessive spraying of any aerosol gun care product, especially where it may get on ammunition. All lubricants and aerosol spray lubricants, in particular, can penetrate cartridge primers and cause misfires. Some highly penetrative lubricants can also migrate inside cartridge cases and cause deterioration of the propellant powder; on firing, the powder may not ignite. If only the primer ignites, there is danger that the bullet may become lodged in the barrel.

⚠ WARNING – AMMUNITION

Death, serious injury, and damage can result from the use of wrong ammunition, bore obstructions, powder overloads, or incorrect cartridge components. Always wear shooting glasses and hearing protectors.

IMPROPER AMMUNITION DESTROYS FIREARMS**⚠ WARNING – LEAD EXPOSURE**

Discharging firearms in poorly ventilated areas, cleaning firearms, or handling ammunition may result in exposure to lead and other substances known to the state of California to cause birth defects, reproductive harm, and other serious physical injury. Maintain adequate ventilation at all times. Wash hands thoroughly after exposure.

SHOOTING OR CLEANING FIREARMS MAY EXPOSE YOU TO LEAD

4.0 Handling

4.1 Preparation Instructions

Prior to firing the pistol for the first time, we strongly suggest you perform an initial cleaning and lubrication of the pistol once it is unpacked. Any fouling present will have been from final range firing at the factory prior to shipping. Please refer to Section 8.0 for instructions pertaining to cleaning the pistol.

If you have the pistol and ammunition, and have read and understood all of the safety instructions, you are now ready to use the pistol.

4.2 Manual Safety Equipped Pistols

The SIG P320 is offered with an optional ambidextrous manual safety. The manual safety mechanically blocks the movement of the sear preventing release of the striker.

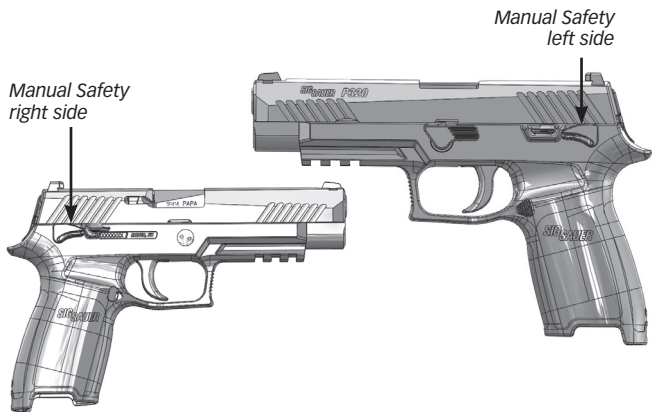

To engage the manual safety, rotate the safety lever upward with the thumb of the firing hand. The manual safety is ambidextrous. Pressing up on the lever from either side will rotate the opposite lever upward, engaging the manual safety. The slide can still be manipulated with the manual safety engaged.

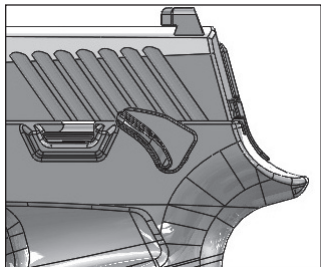

Manual safety engaged (Left side)

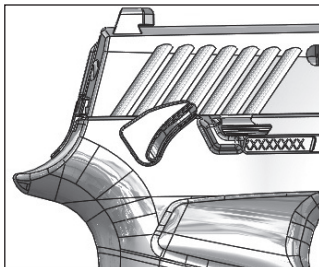

Manual safety engaged (Right side)

4.3 Magwell Equipped Pistols

The P320 X-FIVE comes standard with a detachable magazine well. This magazine well facilitates faster reloading of the pistol. It can be detached from the P320 X-grip module by removal of the retention screw.

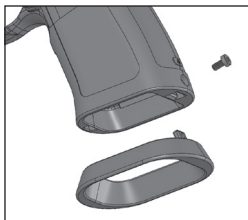

4.4 Loading the Magazine

1. Ensure the magazine is the proper type and caliber for the pistol.
2. Press down on the magazine follower with the cartridge case rim. Ensure the bullet is facing the front of the magazine.
3. Push the cartridge to the rear and under the magazine lips.
4. Repeat until the magazine holds the desired number of cartridges. Do not attempt to insert more cartridges than the magazine designed capacity.



4.5 Loading the pistol (ready to fire)

1. Point pistol in a safe direction. Engage manual safety if so equipped.
2. Fully retract slide and lock slide to the rear by pushing up on slide catch lever.
3. Visually and physically inspect chamber to ensure it is clear.
4. Inspect breech face and magazine well for any foreign debris.
5. Insert a loaded magazine pushing it up into grip module until it locks in place. You should hear an audible click.
6. Release the slide by either:

- a. Pressing down on the slide catch lever releasing the slide forward, chambering a cartridge.
- b. Slightly pull back on the slide and release it to chamber a cartridge. Do not ride the slide forward. Failure to properly complete step b may induce a stoppage.

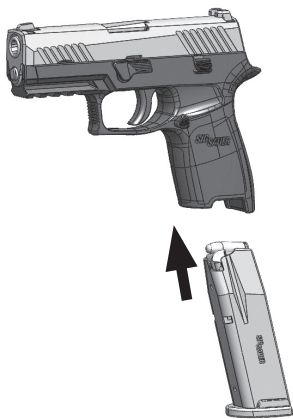
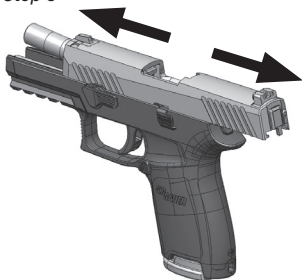
Step 2*Step 3**Step 4*

⚠ WARNING – LOADED PISTOL

THE PISTOL IS NOW LOADED AND READY TO FIRE.

4.6 Reloading During Shooting

When the last round in the magazine is expended, the slide will be locked back in the open position by the slide catch lever.

1. Depress the magazine catch.
2. Remove the empty magazine.

Step 1



Step 2

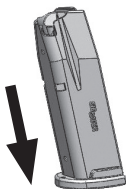
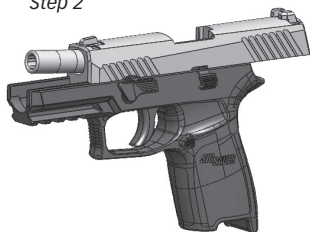

3. Insert a loaded magazine, making sure it is engaged.
4. Release the slide by:
 - a. Pressing down on the slide catch lever or,
 - b. Pulling back on the slide and release

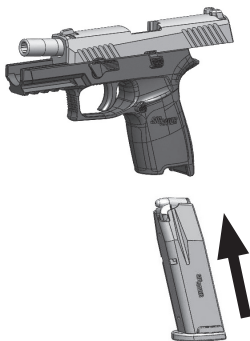
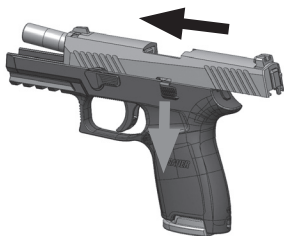
Step 3*Step 4***⚠ WARNING – LOADED PISTOL****THE PISTOL IS NOW LOADED AND READY TO FIRE.**

Always make sure the muzzle is pointed in a safe direction! Never attempt to load or unload any firearm inside a vehicle, building, or other confined space (except a properly constructed shooting range). Enclosed areas frequently offer no completely safe direction to point the firearm; if an accidental discharge occurs, there is great risk of bodily injury or property damage. Before loading, always clean all grease and oil from the bore and chamber, and check to be certain that no obstruction is in the barrel. Any foreign matter in the barrel could result in a bulged or burst barrel or other damage to the firearm, and could cause serious injury to the shooter or to others.

5.0 Firing

⚠ WARNING – TRIGGER

DO NOT TOUCH THE TRIGGER UNTIL YOU ARE ACTUALLY READY TO FIRE THE PISTOL.

Keep the muzzle pointed in a safe direction and your finger off of the trigger and out of the trigger guard when cocking any firearm.

Never fire any firearm with your finger, hand, face, or other part of your body over or adjacent to the ejection port, or in any position where you may be struck by reciprocating movement of the breech. Both the ejection of empty cartridge cases and the movement of the breech are part of the normal operating cycle of firearms, and pose no safety hazard to the shooter if the firearm is held in a normal grip and fired at arm's length.

Never allow other persons to stand beside you where they might be struck by an ejected cartridge case. The case is hot, and may be ejected with sufficient force to cause a burn, cut, or other injury. Wear safety glasses to protect eyes. Make certain there is a clear, unobstructed path for safe ejection of the fired case. Remember, the case may bounce off a hard object nearby and strike you or someone else.

⚠ WARNING – STOPPAGE

If, while shooting, your firearm develops a stoppage or binding, or “spits” powder/gas, or if a cartridge primer is punctured, or a cartridge case is bulged or ruptured, or if the report on firing does not sound quite right, STOP SHOOTING IMMEDIATELY! It may be dangerous to continue. UNLOAD AND CLEAR THE FIREARM – DO NOT try “one more shot.” Take the firearm and the ammunition to a gunsmith for examination.

5.1 Clearing a Stoppage

While shooting any firearm, an unfired cartridge or fired cartridge case may occasionally become jammed between the slide and the barrel. WHILE KEEPING THE MUZZLE POINTED IN A SAFE DIRECTION, clear the stoppage as follows:

1. Engage manual safety if so equipped.
2. Press magazine catch and remove magazine.
3. Pull back slide and lock it to the rear by pushing up on the slide catch lever.
4. Dislodge any expended casings or live cartridges from pistol.
5. Visually and physically inspect chamber and breech face to make sure pistol is cleared.

⚠ WARNING – EJECTION



The slide opens and shuts quickly while firing. Keep face and hands away from it. Hot brass and powder gas is ejected quickly and can burn you. Always wear safety glasses and hearing protectors.

SLIDE OPENS FAST – HOT BRASS EJECTED

5.2 Firing the Pistol

1. Aim the pistol at a safe target and disengage manual safety if so equipped.
2. Place finger on the trigger and press trigger to discharge.

Step 3



3. Keep pistol aimed at the target and continue to fire as required or until the magazine is empty.
4. Remove the magazine, unload and clear the pistol (see section 6.0 "Unloading the Pistol"). If the pistol is fired until the magazine is empty, the slide will remain locked to the rear. If firing is to continue, reload the pistol (see section 4.4 "Reloading During Shooting").
5. Engage the manual safety if so equipped. Press magazine catch to remove the magazine, unload.

6.0 Unloading the Pistol

⚠ WARNING – UNLOADING

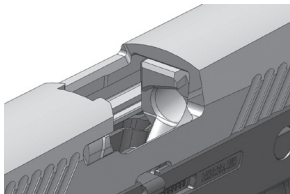

Removing cartridges from the magazine does not prevent the pistol from being fired! When there is a cartridge in the chamber, the cartridge will discharge if the trigger is pressed. It is absolutely essential for the user to know how to completely unload the pistol. "Completely" means emptying the magazine and removing a chambered cartridge.

PISTOL WILL FIRE WITH MAGAZINE EMPTY OR REMOVED

6.1 Unloading the Pistol (Magazine Not Empty)

1. Keep the muzzle pointed in a safe direction and engage manual safety if so equipped.
2. Press the magazine catch and remove the magazine.
3. Pull the slide completely to the rear while watching for ejection of live cartridge. Push up on slide catch lever locking slide open.
4. Visually and physically check the chamber to ensure the pistol is completely free of ammunition.
5. Depress the slide catch lever, causing the slide to close.
6. Unload the magazine.

Step 2



Step 3



Step 4

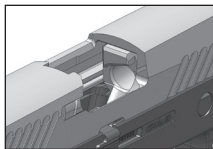

Step 5



Step 6



6.2 Unloading the Pistol (Magazine Empty, Slide Open)

1. Keep the muzzle pointed in a safe direction and engage manual safety if so equipped.
2. Depress the magazine catch and remove the magazine.
3. Visually and physically check the chamber to ensure the pistol is completely free of ammunition.
4. Depress the slide catch lever, causing the slide to close.

Step 2

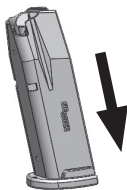
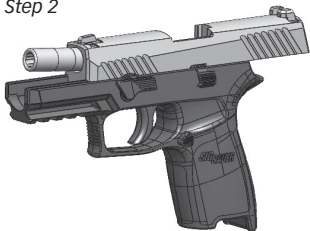

Step 3

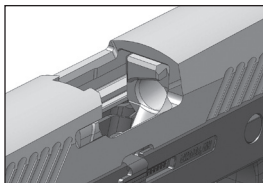

Step 4



Always make sure the muzzle is pointed in a safe direction! Remember to clear the chamber after the magazine has been removed.

Never assume that any firearm is unloaded until you have personally checked it, visually and physically!

After every range session, make a final check to be certain the firearm is unloaded before leaving the range.

⚠ WARNING – UNLOADING

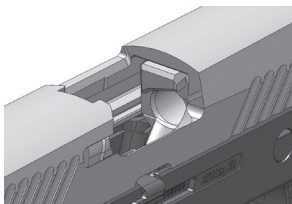

Removing cartridges from the magazine does not prevent the pistol from being fired! When there is a cartridge in the chamber, the cartridge will discharge if the trigger is pressed. It is absolutely essential for the user to know how to completely unload the pistol. "Completely" means emptying the magazine and removing a chambered cartridge.

PISTOL WILL FIRE WITH MAGAZINE EMPTY OR REMOVED

7.0 Procedures in Case of a Stoppage

Follow the immediate action procedures if:

- You notice that a cartridge is difficult to chamber
- A cartridge does not go off
- The mechanism fails to extract a fired cartridge case
- You discover unburned grains of propellant powder spilled in the mechanism
- A shot sounds or feels weak or abnormal

⚠ WARNING – STOPPAGE

LIVE ROUND JAM MAY NOT EJECT.

Firearms work reliably if properly maintained. If there is a stoppage during firing:

1. Keep the pistol pointed in a safe direction with your finger off the trigger and engage manual safety if so equipped.
2. Remove and secure the magazine.
3. Cycle the slide rearward and forward to clear any live cartridge or expended case in or near the chamber. Visually and physically inspect the breech face and chamber.
4. If you suspect that a bullet is lodged in the bore, field strip your pistol and check to see if the barrel is blocked. If there is a bullet lodged in the bore, return the pistol to SIG SAUER (see section 12.3 "Shipping Firearms for Repair").

⚠ WARNING – STOPPAGE

IF A BULLET IS IN THE BORE, DO NOT ATTEMPT TO SHOOT IT OUT BY USING ANOTHER CARTRIDGE, OR BY BLOWING IT OUT WITH A BLANK OR A CARTRIDGE FROM WHICH THE BULLET HAS BEEN REMOVED. THIS CAN GENERATE EXCESSIVE PRESSURE, DAMAGE THE FIREARM AND CAUSE SERIOUS PERSONAL INJURY OR DEATH.

7.1 Troubleshooting Guide

Stoppage	Cause	Correction
Failure to Feed		
No round fed into the chamber	Magazine not properly inserted or magazine is deformed or dirty	Insert magazine properly or change magazine
Slide does not close easily or completely	Pistol or cartridge is fouled (dirty) or pistol is too heavily lubricated	Clean and lubricate pistol and/or replace the ammunition
	Incorrect ammunition	Replace ammunition
	Pistol requires service	Return to SIG SAUER
Failure to Extract or Eject		
After firing, the case stays in the chamber or is jammed in the ejection port	Insufficient recoil due to dirt	Clean and lubricate the pistol
	Light hold or limp wrist	Solid grip, rigid hold
	Low-powered ammunition	Change ammunition
	Pistol requires service	Return to SIG SAUER
Failure to Fire		
Trigger is fully pressed but round does not fire	Striker obstructed	Inspect, clean and lubricate the pistol
	Faulty ammunition	Manually cycle in next round
	Pistol requires service	Return to SIG SAUER

Stoppage	Cause	Correction
Dead Trigger/Cannot Insert Magazine (After Reassembly)		
Cannot seat magazine in grip module.	Improper assembly of slide to receiver (takedown safety lever incorrectly positioned).	<ol style="list-style-type: none"> 1. Lock slide to rear with slide catch lever. 2. Press slide catch lever to release slide forward. 3. Insert magazine.

⚠ WARNING – STOPPAGE

If your pistol stops firing with a live round in the chamber of a hot barrel (a misfire or stoppage), remove the round immediately. If you cannot remove the round within 10 seconds, remove the magazine and wait at least 15 minutes with the pistol pointing in a safe direction. This way, neither the user nor any other person would be injured by the possibility of a round “cooking-off” (a round detonating due to the heat of the barrel). Keep your face away from the ejection port while clearing a hot chamber.

7.2 Minimizing Stoppages

Stoppages can largely be avoided by cleaning and lubricating the pistol (see section 8.3 “Cleaning the Pistol”).

- After each firing session
- Whenever a buildup of firing residue is suspected
- Whenever the pistol is exposed to extreme environmental conditions (rain, snow, freezing temperatures, etc.)

8.0 Maintenance

⚠ WARNING – MAINTENANCE

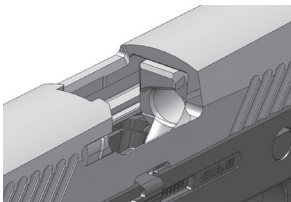

Verify the magazine is removed – visually and physically confirm the pistol is unloaded and cleared before attempting disassembly or performing any maintenance steps. Failure to ensure the firearm is unloaded and cleared could result in unintentional discharge, causing severe injury or death, or property damage.

VERIFY THE FIREARM IS UNLOADED AND CLEARED

8.1 Pistol Disassembly

1. Unload the pistol (see section 6.0 “Unloading the Pistol”).
2. Retract the slide and lock open by engaging the slide catch lever.
3. Verify visually and physically that there is no round in the chamber.
4. Rotate the takedown lever clockwise until the takedown lever can no longer rotate.
5. Retract the slide slightly to disengage the slide catch lever. Allow the slide to move forward in a controlled fashion.

⚠ WARNING – DISASSEMBLY

Slide is under spring tension. Maintain positive control during slide removal to prevent damage or injury. Wear eye protection.

6. Move the complete slide assembly (slide, barrel, recoil spring and guide) forward and off the frame.

Step 2



Step 4

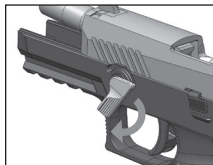

Step 5

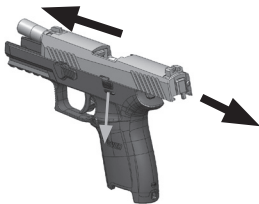

Step 6



7. Push the recoil spring guide forward slightly and lift from rear to remove the recoil spring and guide from the slide.

8. Remove the barrel from the slide by pulling upward slightly and to the rear. This level of disassembly is sufficient to allow a thorough cleaning after shooting.

Step 7

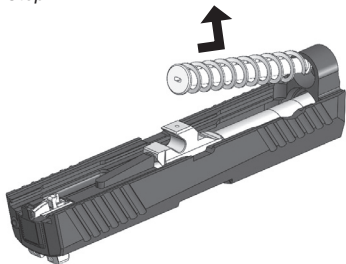

Step 8

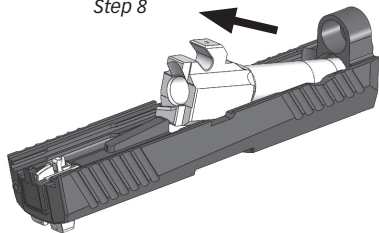

8.2 Magazine Disassembly

1. Locate the bottom of the magazine floorplate.
2. Using a punch, cleaning rod, or similar tool, push the tab of the insert forward, then down, to release the floorplate.

⚠ WARNING – DISASSEMBLY

The magazine spring is compressed. Guard the magazine insert and magazine spring with your thumb to control the release of magazine spring tension. Uncontrolled release can cause injury. Wear eye protection.

3. Remove the magazine follower and magazine spring from the magazine tube. This level of disassembly is sufficient to allow a thorough cleaning after shooting.

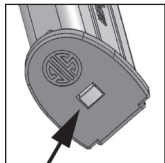
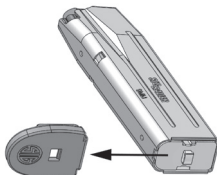
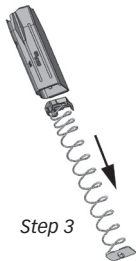
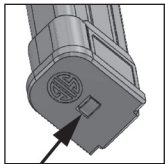
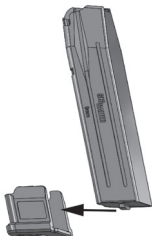
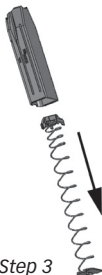
Standard Magazine*Step 1**Step 2**Step 3***Extended Magazine***Step 1**Step 2**Step 3*

8.3 Cleaning the P320 Pistol

⚠ WARNING – CLEANING

NEVER CLEAN THE BARREL FROM THE MUZZLE END; DO NOT USE A STEEL WIRE BRUSH AS IT CAN DAMAGE THE SMOOTH SURFACE OF THE BARREL. USE A SUITABLE CLEANING ROD AND A BRONZE BRUSH OF THE CORRECT CALIBER.



SOLVENTS CAN BE HARMFUL TO THE SURFACE FINISH OF THE PISTOL. READ AND FOLLOW THE MANUFACTURER'S WARNINGS BEFORE USING SOLVENTS OR CLEANERS. WEAR EYE PROTECTION.

AVOID OVER-LUBRICATION OF COMPONENTS.

⚠ WARNING – LUBRICATION

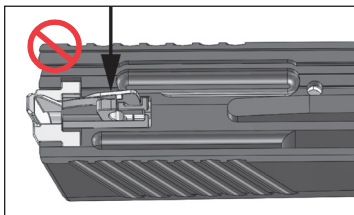

DO NOT LUBRICATE THE STRIKER OR ALLOW LUBRICANT TO FLOW INTO THE STRIKER CHANNEL OF THE SLIDE. THIS MAY CAUSE A LIGHT STRIKE TO THE CARTRIDGE RESULTING IN A FAILURE TO FIRE.

MATERIALS REQUIRED

- Cleaning patches
- Rag, Wiping
- Bore brush of the proper caliber
- Cleaning rod
- CLP (Cleaning, Lubricant, Protective) or LSA (Lubricant, Small Arms)
- LAW (Lubricant, Arctic Weather) when applicable
- Brush, Cleaning

The following instructions are for normal environmental conditions. Clean and lube before or after every day the pistol is fired or at a minimum of every 500 rounds.

SLIDE ASSEMBLY

1. Remove all of the old lubricant before you reapply.
2. Clean the slide assembly with a cloth. A soft brush and CLP can be used to clean excessive dirt and carbon buildup. Ensure the extractor, rail slots and breech face are free of dirt and residue.
3. Apply a light coat of CLP/LSA to the frame rail slots of the slide.
4. Lightly oil all external parts.
5. Do not lubricate the striker assembly.

BARREL

1. Soak a patch with CLP and push it through the bore from the chamber end and out past the muzzle.
2. Allow the CLP to soak for a while to loosen residue and soften carbon deposits.
3. Wipe the exterior of the barrel with a cloth soaked in CLP.
4. Repeat step #1.
5. Use the bore brush and a cleaning rod to scrub heavy deposits from the bore.
6. Repeat step #1.
7. Push dry patches through the bore until they come out clean.
8. Lightly oil bore and chamber if the pistol is to be stored for a period of time.
9. Always remove any lubricant from the bore prior to firing the pistol.

RECOIL SPRING AND GUIDE ASSEMBLY

The P320 recoil spring and guide assembly is not to be disassembled. It is serviced as a single unit.

1. Clean the recoil spring guide assembly with CLP and a soft brush.
2. After cleaning, apply a light coat of CLP/LSA.

FRAME/GRIP MODULE ASSEMBLY

1. Wipe the frame and grip module assembly with a soft cloth.
2. Use cotton swabs to clean hard to reach areas. Pay special attention to the frame rails, takedown lever and slide catch lever.
3. Lubricate the frame rails with a light coat of CLP/LSA.
4. Apply CLP/LSA to accessible functioning parts.
5. Clean the magazine well of any dirt, dust or residue with a soft cloth.

MAGAZINE

1. Wipe the magazine tube and follower with a cloth. Clean the magazine tube and follower with a soft brush and CLP.
2. Use a cloth to clean the magazine spring, floorplate, and base plate.
3. Apply a light coat of CLP/LSA to the spring and magazine tube.

8.4 Pistol Assembly

1. Verify the pistol is clear of all foreign matter.
2. Insert the barrel into the slide.

Step 2

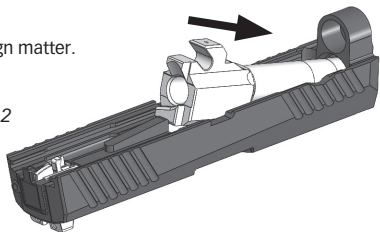

⚠ WARNING – ASSEMBLY



The recoil spring and guide are under spring tension. Use caution to prevent injury or damage to the pistol. Wear eye protection.

3. For Full Size insert recoil spring guide assembly into the slide.
3a. For Compact/Sub-Compact Insert the recoil spring assembly into the slide. You must rotate the spring guide so the flats are vertical.

Full Size
Step 3

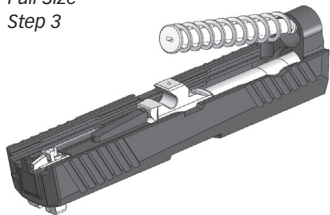

Compact/Sub-Compact
Step 3a

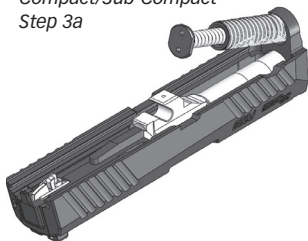

4. Ensure the takedown lever is rotated clockwise fully to the stop.
5. Guide the slide onto the frame rails from the front.
6. Retract the slide fully to the rear. Engage the slide catch lever to lock the slide in the open position.
7. Rotate the takedown lever counter-clockwise until horizontal.
8. Depress the slide catch lever to release the slide.

Step 4

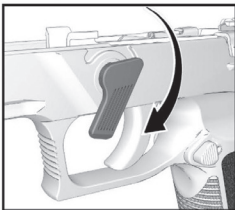

Steps 5, 6, & 7



Step 8

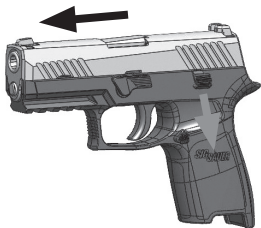

8.5 Magazine Assembly

1. Orient the magazine follower on the magazine spring and insert into the bottom of the magazine tube.

⚠ WARNING – ASSEMBLY



The magazine spring is being compressed during assembly. Guard the magazine insert and magazine spring with your thumb to control magazine spring tension. Uncontrolled release can cause injury. Wear eye protection.

2. Insert the magazine spring fully into the magazine tube until the magazine insert is flush with the magazine tube bottom.

3. Holding the magazine insert in place, slide the magazine floorplate onto the magazine tube lips until the magazine floorplate is locked in place by the magazine insert.

Step 2

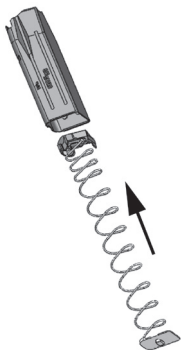

Step 3

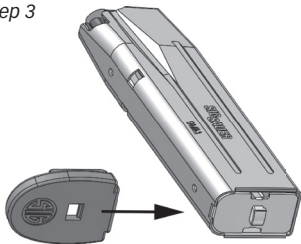

8.6 Function Verification

The function check is performed on the assembled pistol to verify functionality. It should be performed after the completion of repairs and after each cleaning and assembly of the pistol.

⚠ WARNING – MAINTENANCE

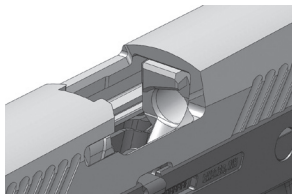

Verify the magazine is removed – visually and physically confirm the pistol is unloaded and cleared before attempting disassembly or performing any maintenance steps. Failure to ensure the firearm is unloaded and cleared could result in unintentional discharge, causing severe injury or death, or property damage.

VERIFY THE FIREARM IS UNLOADED AND CLEARED

1. Ensure the magazine is removed and the pistol is unloaded and cleared (see section 6.0 "Unloading the Pistol").
2. Check recoil spring function/slide travel.
 - a. Retract the slide fully and release.
 - b. Verify the slide locks fully in the closed position.
 - c. Repeat the procedure.
3. Check the trigger mechanism:
 - a. Press the trigger fully to the rear.
 - b. As the trigger is pressed rearward the striker is released causing an audible click.

Step 2a



Step 3a - 3b



4. Check slide catch lever.
 - a. Insert an empty magazine.
 - b. Retract the slide fully and release.
 - c. Verify the slide is locked to the rear by the slide catch lever.
 - d. Depress the slide catch lever.
 - e. Verify the slide is released and closes in the locked position.
 - f. Remove the magazine.

Step 4a, 4b & 4c

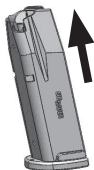
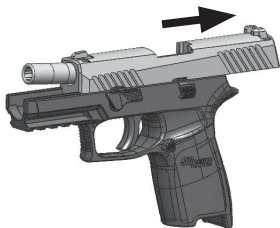

Step 4d & 4e

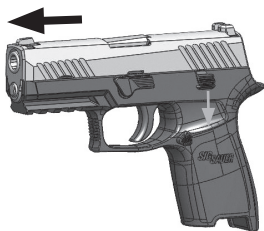

Step 4f



5. Inspect the magazine.
 - a. Check the condition of the magazine tube.
 - b. Verify the magazine floorplate is secure.
 - c. Check for free movement of the magazine follower and spring.
 - d. Insert the magazine into the pistol and remove. Verify smooth insertion. Check the magazine catch for clean engagement and smooth release.

6. Inspect the pistol exterior.
 - a. Inspect the general condition of the pistol.
 - b. Check the sights, body, slide, and takedown lever for damage.
 - c. Verify the front and rear sights are secure.

Step 5d

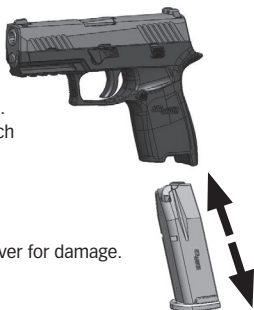

⚠ WARNING – INSPECTION

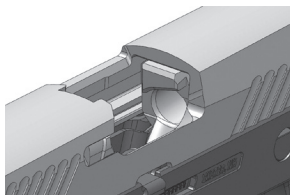

Never use a firearm or magazine that shows signs of damage or fails a function check. Verify the magazine is the correct model and caliber for the pistol. If the condition or function of the pistol or magazine is suspect, return the pistol or magazine to SIG SAUER for evaluation.

VERIFY THE CONDITION AND FUNCTION

9.0 Pistol Adjustments

9.1 General Information

The P320 pistol is designed for both right-hand and left-hand operation and a variety of hand sizes. The slide catch lever can be operated from either side. The magazine catch may be repositioned to either side based on shooter preference. The grip module may be replaced by the shooter, providing a range of ergonomically correct grip configurations.

⚠ WARNING – UNLOADING

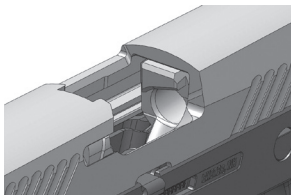

Verify the magazine is removed and visually and physically confirm the pistol and chamber are unloaded and cleared before attempting disassembly or performing any maintenance steps. Failure to ensure the firearm is unloaded and cleared could result in unintentional discharge, causing severe injury or death, or property damage.

VERIFY THE FIREARM IS UNLOADED AND CLEARED

9.2 Magazine Catch Removal and Reversal

1. Depress the magazine catch until the back protrudes slightly from the opposite side and hold.
2. On the protruding side, press the straightened end of a paper clip into the hole on the back side of the magazine catch to release the magazine catch stop.
3. Remove the magazine catch stop.
4. Remove the magazine catch and magazine catch spring, keeping the two pieces together.
5. Insert the magazine catch and magazine catch spring on the desired side of the pistol body.
6. Insert the magazine catch stop from the opposite side until the magazine catch stop latch engages.

Step 2

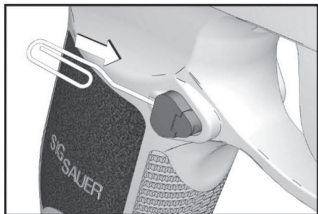

Steps 3 & 4

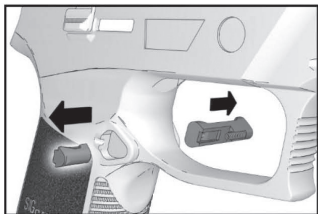

Steps 5 & 6

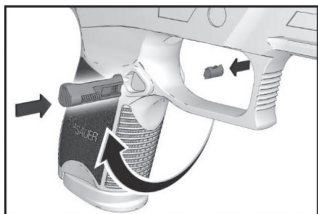

9.3 Changing the Grip Module

9.3.1 Disassembly

If your P320 is fitted with a Tamper Resistant Takedown Lever, removing the grip module is not authorized. You must evacuate the pistol to the next authorized level of maintenance to have this performed.

1. Remove the slide but not the recoil spring and recoil spring guide (see section 8.1 "Pistol Disassembly").
2. Remove the takedown lever (turn and pull simultaneously).
3. Push the frame assembly forward.
4. Pull up on the frame rails and remove to rotate the frame assembly out from the grip module.

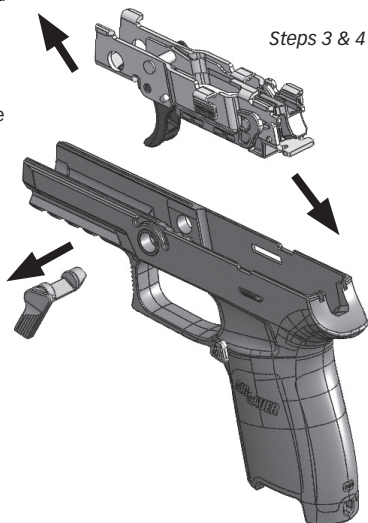

⚠ WARNING – DISASSEMBLY

Do not attempt to disassemble your pistol beyond the point explained in this manual. Further disassembly should only be done at the factory. Some of the components require special skills, tools and fixtures for disassembly.



DO NOT DISASSEMBLE BEYOND INSTRUCTIONS

9.3.2 Assembly

1. Insert the frame assembly locking tab into the mating slot inside the rear of the grip module.
2. Press down on the frame rails, rotating the frame assembly into position.
3. Insert the takedown lever (turn and push simultaneously) through the corresponding hole on the left side of the grip module/frame assembly, locking the frame assembly in place.
4. Assemble the pistol (see section 8.4 "Pistol Assembly").

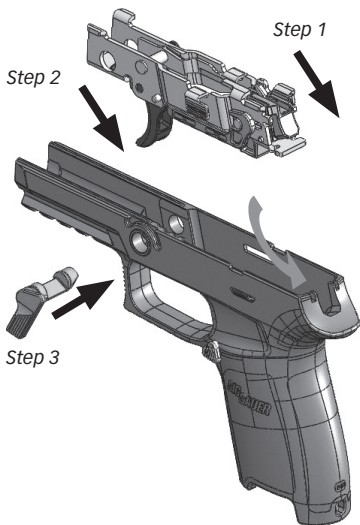

⚠ WARNING – ALTERATIONS

This product was designed to function properly in its original condition. Alterations can make it unsafe. Do not alter any part or add or substitute any parts or accessories not manufactured by SIG SAUER for this pistol.



DO NOT ALTER ANY FIREARM

10.0 Sights

▲ WARNING – TRITIUM SIGHTS



Some SIG SAUER pistols come equipped with sights that contain radioactive material for illumination during low light conditions or hours of darkness. The sights are marked with the letters "SIG" and "H3". The radiation source is Hydrogen-3 (H3), commonly known as tritium. The activity level of tritium in SIG SAUER night sights range from 12 mCi (millicuries) to 30 mCi. The operational temperature range of SIG SAUER tritium sights is -30C/-22F to +60C/140F. The beta radiation emitted by tritium is only a hazard if the tritium vial is broken and is ingested or inhaled by humans. The body does not easily retain hydrogen or tritium as a gas. However, the oxide HTO, which is formed by the burning of tritium is 10,000 times more hazardous. For this reason great care should be taken to avoid flame in the presence of damaged tritium sights. Disposal of tritium sights must be performed in a controlled manner. If you suspect that the sight containing a tritium vial has broken, DO NOT ATTEMPT TO DISASSEMBLE THE SIGHT. Follow these instructions.

Damaged Sights Only (sights removed from firearm):

Place damaged sights in a small zip lock bag and label it "**Damaged Tritium Sight DO NOT OPEN**". Place the zip lock bag in a shipping envelope marked "NIGHT SIGHT FOR DISPOSAL" and send to:

SIG SAUER, Inc.
357 Sig Sauer Drive
Jacksonville, AR 72076

Slide with Damaged Sights:

Call customer service at (603) 610-3000 Ext.1 for instructions and return authorization.

▲ WARNING – DO NOT DISCARD DAMAGED TRITIUM SIGHTS IN THE TRASH



After contact with a suspected damaged tritium sight, wash your hands carefully with soap and water. Do not handle damaged sights if you have open skin cuts or abrasions. Do not eat, drink, smoke or apply cosmetics in the presence of a defective sight vial.

10.1 General Information

The SIG SAUER P320 pistol is equipped with drift adjustable fixed sights which have proven their worth under severe conditions. The sights consist of a rear sight and a front sight blade, designed and dimensioned to ensure rapid target acquisition even when visibility is poor. Some P320 models are equipped with a fully adjustable rear sight.

⚠ WARNING – SIGHT ADJUSTMENT

Fixed sight corrections should only be performed by someone with the necessary knowledge – the pistol could become damaged.

10.2 Windage (Left/Right) Adjustment

Change windage by moving the rear sight either to the left or right in its dovetail. When you do this, follow the rear sight rule: Move the rear sight in the direction you want the group to go. Moving the rear sight 0.020" in the dovetail changes the point of impact by approximately 3" at 25 yards.

Note: SIG SAUER has a Sight Adjustment Tool available that makes it easier to adjust and change fixed sights.

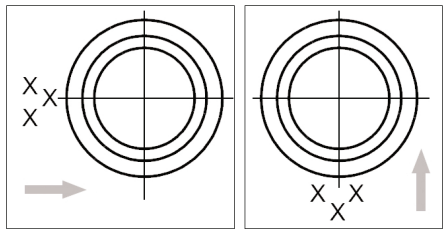

Impact left of point of aim

Impact low of point of aim

10.3 Elevation (Up/Down) Adjustment

There are different height combinations available for the front and rear sights. The sights are numbered according to their height. You can change elevation by changing either the rear or front sight. It's easier if you change the rear sight first. There are six rear sight heights available. Each rear sight change will move the impact of the bullet approximately 2" at 25 yards. There are five front sight heights available. Each front sight change will move the impact of the bullet approximately 1" at 25 yards.

When changing sights, remember this rule: NUMBERS UP, GROUPS UP; NUMBERS DOWN, GROUPS DOWN. This is true for both front & rear sights.

⚠ WARNING – SIGHT ADJUSTMENT

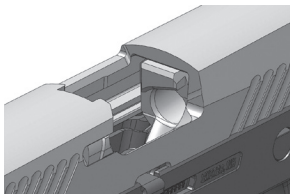

Sight corrections should **ONLY** be performed on an unloaded firearm. Manipulating the sights on a loaded firearm could result in unintentional discharge, causing severe injury or death, or property damage. Visually and physically confirm the pistol is unloaded and cleared before making sight adjustments.

DO NOT ADJUST THE SIGHTS ON A LOADED FIREARM

10.4 Sight Adjustment P320 X-Series Pistol

The P320 X-FIVE has a fully adjustable rear sight.

Elevation: Counter-clockwise rotation of the screw will raise the rear sight, moving the impact up. Clockwise rotation of the screw will move the point of impact down.

Windage: Counter-clockwise rotation of the windage screw will move the rear sight aperture left, moving the point of impact left. Clockwise rotation of the screw moves the rear sight aperture right, moving the impact right.

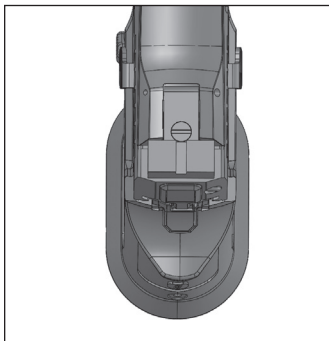

Sight Adjustment
Fully Adjustable Rear Elevation

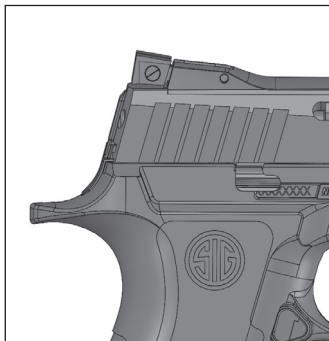

Windage Adjustment
Fully Adjustable Rear

11.0 Transportation and Storage

When transporting your firearm to and from shooting activities, keep it unloaded for your safety and for the safety of others. When storing your firearm, keep it separated from ammunition, under lock and key if possible, and out of the reach of children and other inexperienced or unauthorized persons.

⚠ WARNING – STORAGE

Never place or store any firearm in such a manner that it may be dislodged. Firearms should always be stored securely and unloaded, away from children and other unauthorized users. Use the locking device originally supplied with this firearm for storage. The use of a locking device or safety lock is only one aspect of responsible firearms storage. For increased safety, firearms should be stored unloaded and locked in a location that is both separate from their ammunition and inaccessible to children and any other unauthorized person.



STORE SECURELY AND UNLOADED

12.0 Service and Parts Policy

12.1 Parts Policy

Our Service Department maintains a full complement of replacement parts. Even though most gunsmiths have the knowledge, training, and the ability to make necessary repairs to your firearm, the skill and workmanship of any particular gunsmith is totally beyond our control.

Should your firearm ever require service, we strongly recommend that you return it to SIG SAUER (see section 12.3 “Shipping Firearms for Repair”). A firearm is a precision instrument and some replacement parts will require individual fitting to ensure correct operation. A wrong part, improper fitting, or incorrect mechanical adjustment may result in an unsafe condition or dangerous malfunction, damage to the firearm, or cause possible serious injury to the shooter or others.

IF ANY PART IS ORDERED WITHOUT RETURNING THE FIREARM TO SIG SAUER, the customer bears full responsibility for ensuring that the part supplied is correct for their particular firearm and is properly installed and fitted by a qualified gunsmith.

SIG SAUER CANNOT BE RESPONSIBLE FOR THE FUNCTIONING OF ANY FIREARM IN WHICH REPLACEMENT PARTS ARE INSTALLED BY OTHERS.

⚠ WARNING – PARTS PURCHASERS

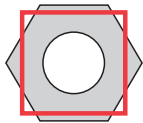

It is the purchaser's responsibility to be absolutely certain that any parts ordered from the factory are correctly fitted and installed. Firearms are complicated mechanisms and **IMPROPER FITTING OF PARTS MAY RESULT IN A DANGEROUS MALFUNCTION, DAMAGE TO THE FIREARM, AND SERIOUS INJURY TO THE SHOOTER AND OTHER PERSONS.** The purchaser and installer of parts must accept full responsibility for the correct adjustment and functioning of the firearm after such installation. **PARTS MUST FIT CORRECTLY**

12.2 Service Policy

If you have questions concerning the performance or servicing of your firearm, please write or call:

SIG SAUER, Inc.
Attention: Customer Service
18 Industrial Drive, Exeter, NH 03833
Phone: (603) 610-3000 ext. 1
Fax: (603) 766-7002

IF YOU DO NOT UNDERSTAND THE INSTRUCTIONS FOR OPERATING YOUR PISTOL, IT IS YOUR RESPONSIBILITY TO CALL OUR CUSTOMER SERVICE DEPARTMENT AT (603) 610-3000 EXT. 1 BEFORE USING YOUR FIREARM.

12.3 Shipping Firearms for Repair

In the event you need to return your firearm to the SIG SAUER Service Department, here's what to do:

1. First contact Customer Service at (603) 610-3000 ext. 1 for an RMA number, which will allow SIG SAUER to track the status of your return from its receipt at SIG SAUER through its return to you. Please do not send your firearm until you obtain an RMA number.
2. Make sure that the chamber and magazine(s) are unloaded and that no ammunition is included with your returned firearm.
3. Package the firearm securely to prevent damage. Enclose a letter that includes your name, street address, daytime phone number, model and serial number, and a detailed description of the problem you have experienced or the work you want performed. With the exception of extra magazines, do not include any other accessories such as scopes or mounts.

4. Generally, an individual may ship firearms to the manufacturer for repair or service. Some states and localities, however, prohibit this. If you live in such an area, the firearms must be shipped by and returned to a federally licensed firearms dealer.
5. Federal law prohibits persons who do not possess a Federal Firearms License from shipping a firearm via the U.S. Postal Service. (Note: any shipment of firearms outside U.S. borders is subject to the export laws of the United States and to the valid laws of the specific country, which you must strictly follow; prior to exporting any firearm you should seek legal counsel.)
6. SIG SAUER is not responsible for any firearm until it is received, nor for damage incurred during shipment.
7. Ship your firearms insured and prepaid (we do not accept collect shipments) to:

SIG SAUER, Inc.
Attention: Service Department
18 Industrial Drive Exeter, NH 03833

Don't forget to write your RMA number on the package.

A copy of this instruction manual should always accompany this pistol and be transferred with it upon change of ownership.

12.4 Ordering Parts

In the event you want to order parts for your firearm, contact Customer Service at (603) 610-3000 ext. 1.

Have available the serial number of your firearm and the part diagram number for the part(s) you wish to order. A parts list and diagram of the pistol is provided in section 13.0.

Please refer to the Service and Parts Policy.

⚠ WARNING – SHIPPING

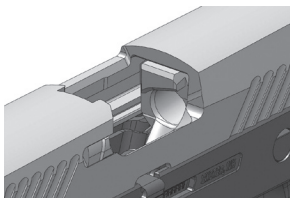

Before shipping any firearm, be absolutely certain that the firearm and its magazines are unloaded and cleared.

DO NOT ship ammunition with a firearm. Failure to follow this warning could result in unintentional discharge, causing severe injury or death, or property damage.

VERIFY THE FIREARM IS UNLOADED AND CLEARED

13.0 Standard Slide Parts Diagram

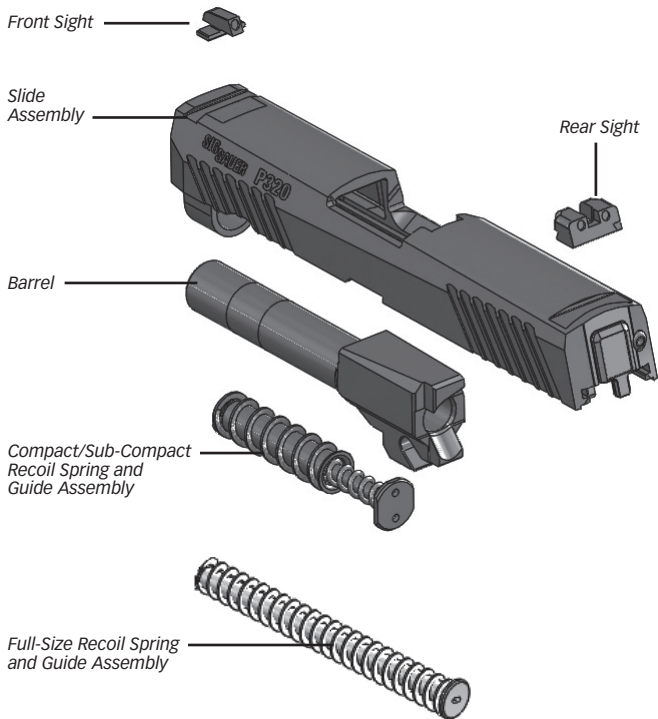

13.1 X-FIVE Slide Parts Diagram

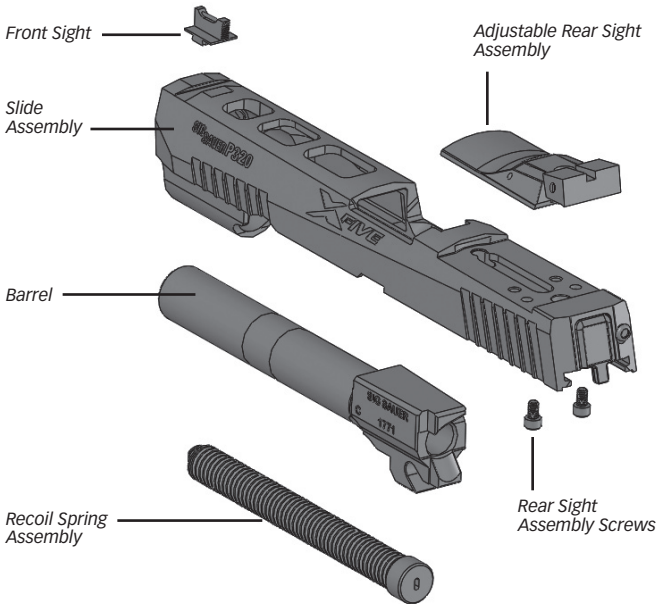

13.2 X-VTAC Slide Parts Diagram

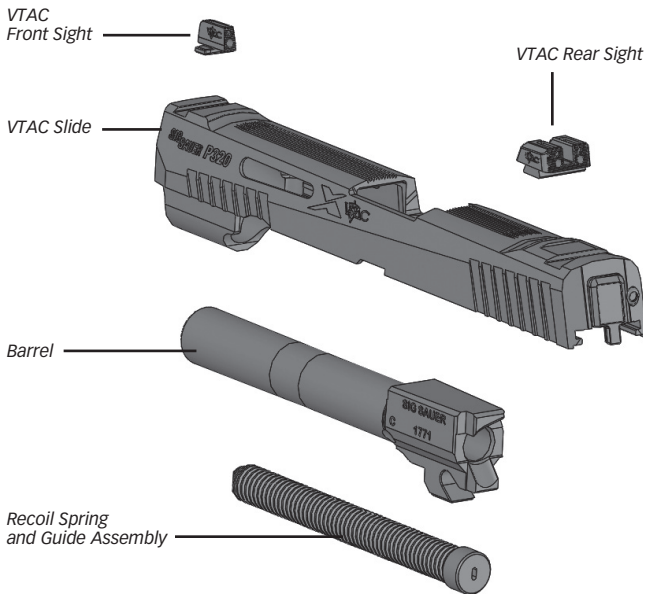

13.3 X-CARRY Slide Parts Diagram

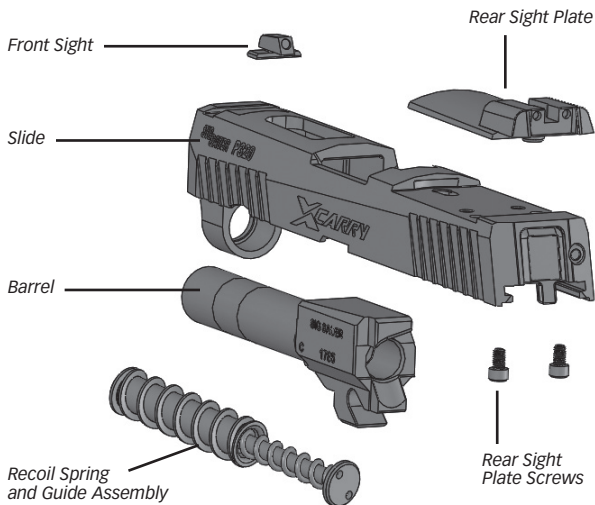

13.4 Standard Frame Parts Diagram

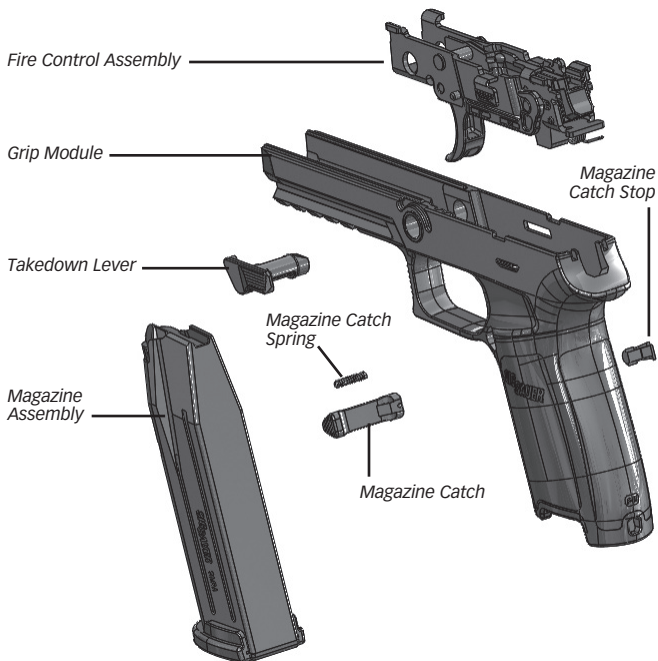

13.5 X-Series Frame Parts Diagram

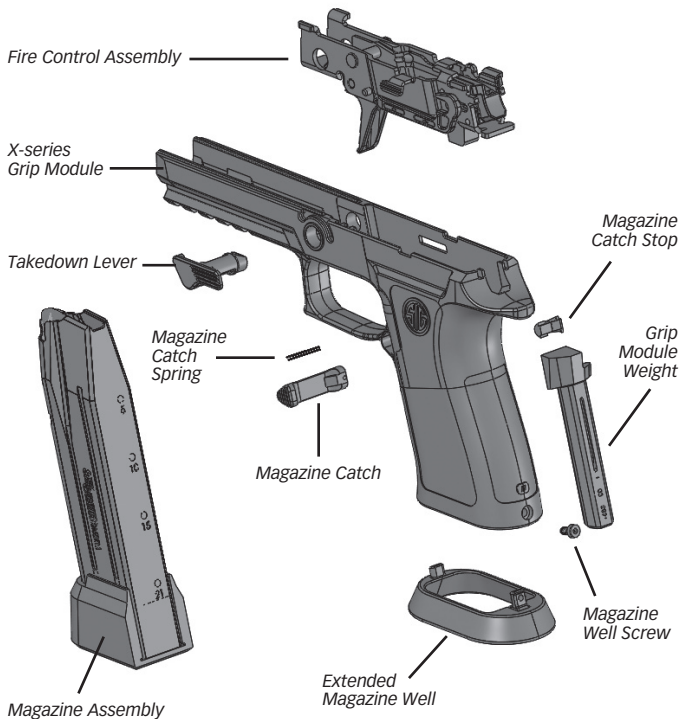

14.0 Technical Specifications

The following information applies to all P320 models.

- Striker fired system.
- Left or right hand operation (magazine catch repositions to either side, slide catch lever functions from both sides).
- Glass reinforced grip module with integral Picatinny rail.
- Interchangeable grip modules available to fit to individual shooter hands.
- Two trigger styles (standard curved & straight).
- Grip modules feature stippled gripping surface for positive control.
- Solid slide of high-strength stainless steel with front and rear cocking serrations.
- High contrast or SIGLITE™ Night Sights in different heights.
- VTAC, X-Ray Night Sights, and Dawson Precision adjustable sights available with select X-series models.

*Specifications are approximate and subject to change without notice.

14.1 Full Size Specifications

Caliber	9mm	.40 S&W	.357 SIG	.45ACP
Length, overall	8.05"	8.05"	8.05"	8.05"
Height, overall	5.51"	5.51"	5.51"	5.51"
Width, overall	1.38"	1.38"	1.38"	1.38"
Barrel length	4.69"	4.71"	4.71"	4.71"
Rifling twist	1 in 10"	1 in 15"	1 in 16"	1 in 16"
Rifling grooves	6	6	6	6
Sight radius	6.64"	6.64"	6.64"	6.64"
Weight incl. magazine	27.6 oz	29.4 oz	29.4 oz	29.6 oz
Magazine wt, empty*	3.09 oz*	3.13 oz*	3.13 oz*	3.36 oz*
Trigger pull	5.5 - 6.5 lbs	5.5 - 6.5 lbs	5.5 - 6.5 lbs	5.5 - 6.5 lbs
Magazine capacity	17 rds	14 rds	14 rds	10 rds

*For manual safety models add 0.5oz to weight.

Specifications are subject to change without notice.

14.2 Compact Specifications

Caliber	9mm	.40 S&W	.357 SIG	.45ACP
Length, overall	7.20"	7.20"	7.20"	7.20"
Height, overall	5.29"	5.29"	5.29"	5.29"
Width, overall	1.38"	1.38"	1.38"	1.38"
Barrel length	3.86"	3.86"	3.86"	3.86"
Rifling twist	1 in 10"	1 in 15"	1 in 16"	1 in 16"
Rifling grooves	6	6	6	6
Sight radius	5.79"	5.79"	5.79"	5.79"
Weight incl. mag	25.7 oz	27.4 oz	27.0 oz	29.7 oz
Mag. wt, empty	3.02 oz	3.00 oz	3.00 oz	3.08 oz
Trigger pull	5.5-6.5 lbs	5.5-6.5 lbs	5.5-6.5 lbs	5.5-6.5 lbs
Mag capacity	15 rds	13 rds	13 rds	9 rds

*For manual safety models add 0.5oz to weight.

Specifications are subject to change without notice.

14.3 Subcompact Specifications

Caliber	9mm	.40 S&W	.357 SIG	.45ACP
Length, overall	6.67"	6.67"	6.67"	6.67"
Height, overall	4.67"	4.67"	4.67"	4.67"
Width, overall	1.06"	1.06"	1.06"	1.06"
Barrel length	3.55"	3.55"	3.55"	3.55"
Rifling twist	1 in 10"	1 in 15"	1 in 16"	1 in 16"
Rifling grooves	6	6	6	6
Sight radius	5.45"	5.45"	5.45"	5.45"
Weight incl. mag	24.9 oz	24.9 oz	25.1 oz	24.8 oz
Mag wt, empty	2.38 oz	2.35 oz	2.35 oz	2.40 oz
Trigger pull	5.5-6.5 lbs	5.5-6.5 lbs	5.5-6.5 lbs	5.5-6.5 lbs
Mag capacity	12 rds	10 rds	10 rds	6 rds

*For manual safety models add 0.5oz to weight.

Specifications are subject to change without notice.

14.4 Carry Specifications

Caliber	9mm	.40 S&W	.357 SIG	.45ACP
Length, overall	7.2"	7.2"	7.2"	7.2"
Height, overall	5.51"	5.51"	5.51"	5.51"
Width, overall	1.4"	1.4"	1.4"	1.4"
Barrel length	3.9"	3.9"	3.9"	3.9"
Rifling twist	1:10	1:15	1:16	1:16
Rifling grooves	6	6	6	6
Sight radius	5.8"	5.8"	5.8"	5.8"
Weight incl. mag	25.9 oz	25.9 oz	25.9 oz	25.9 oz
Magazine wt, empty	3.09 oz	3.13 oz	3.13 oz	3.36 oz
Trigger pull	5.5-7.5 lbs	5.5-7.5 lbs	5.5-7.5 lbs	5.5-7.5 lbs
Mag capacity	17	14	14	10

*For manual safety models add 0.5oz to weight.

Specifications are subject to change without notice.

14.5 X-Series Specifications

	X-FIVE	X-VTAC	X-CARRY
Caliber	9mm	9mm	9mm
Length, overall	8.5"	8.2"	7.4"
Height, overall	5.8"	5.3"	5.3"
Width, overall	1.6"	1.3"	1.3"
Barrel length	5.0"	4.7"	3.9"
Rifling twist	1:10	1:10	1:10
Rifling grooves	6	6	6
Sight radius	6.8"	6.6"	5.8"
Weight incl. mag	35.2 oz	29 oz	26 oz
Magazine wt, empty	3.75 oz	3.09 oz	3.09 oz
Trigger	6.0 lbs	6.0 lbs	6.0 lbs
Mag capacity	21	17	17

Specifications are subject to change without notice.

SIG SAUER® Limited Lifetime Firearms Warranty

SIG SAUER warrants that the enclosed firearm was originally manufactured free of defects in material, workmanship and mechanical function. For the lifetime of the original purchaser, SIG SAUER agrees to correct any defect in the firearm for the original purchaser by repair, adjustment or replacement, at SIG SAUER's option, with the same or comparable quality components (or by replacing the firearms at SIG SAUER's option); provided, however, that the firearm is returned unloaded and freight prepaid to:

**SIG SAUER
18 Industrial Drive
Exeter, NH 03833**

This limited warranty is null and void if the firearm has been misused, damaged (by accident or otherwise), fired with handloaded, reloaded or improper ammunition, fired with an obstruction in the barrel, damaged through failure to provide reasonable and necessary maintenance as described in the manual accompanying the firearm, or if unauthorized repair or any alteration, including of a cosmetic nature, has been performed on the firearm. This limited warranty does not apply to normal wear and tear of any parts. Subject to the foregoing, this limited warranty confers the right to have the covered firearm or its parts repaired, adjusted or replaced exclusively upon the original purchaser, which right is not transferable to any other person. No implied warranties of any kind are made herein and this warranty does not apply to any accessory items attached or appurtenant to the firearm. In no event shall SIG SAUER be liable for any incidental or consequential damages arising from or in connection with this limited warranty.

SIGSAUER[®]
when it counts[®]

www.sigsauer.com

**FOR PRODUCT SERVICE ON THIS MODEL,
PLEASE CALL (603) 610-3000 EXT. 1**

72 Pease Boulevard, Newington, NH 03801 USA