



# Smith & Wesson®

---

## Safety & Instruction Manual For M&P® FPC™

---



**M&P**® **FPC**™



**Read the instructions and  
warnings in this manual  
CAREFULLY BEFORE  
using this firearm.**

2100 Roosevelt Avenue • Springfield, MA 01104  
1-800-331-0852 • Fax: 1-413-747-3317  
[www.smith-wesson.com](http://www.smith-wesson.com)



**WARNING:**



**READ THESE INSTRUCTIONS  
AND WARNINGS CAREFULLY.  
BE SURE YOU UNDERSTAND THESE  
INSTRUCTIONS AND WARNINGS  
BEFORE USING THIS FIREARM.  
FAILURE TO READ THESE INSTRUCTIONS  
AND TO FOLLOW THESE WARNINGS MAY  
RESULT IN INJURY OR DEATH  
TO YOU AND OTHERS AND  
DAMAGE TO PROPERTY.**

**THIS SAFETY & INSTRUCTION  
MANUAL SHOULD ALWAYS  
ACCOMPANY THIS FIREARM AND  
BE TRANSFERRED WITH IT UPON  
CHANGE OF OWNERSHIP OR  
WHEN PRESENTED TO ANOTHER PERSON.  
A COPY OF THE SAFETY & INSTRUCTION  
MANUAL IS AVAILABLE FREE  
VIA DOWNLOAD AT  
[WWW.SMITH-WESSON.COM](http://WWW.SMITH-WESSON.COM)  
OR UPON REQUEST FROM:**

**SMITH & WESSON®  
CUSTOMER SUPPORT CENTER  
2100 ROOSEVELT AVENUE  
SPRINGFIELD, MA 01104  
TEL.: 1-800-331-0852, ext. 4125  
E-mail: [qa@smith-wesson.com](mailto:qa@smith-wesson.com)**

## TABLE OF CONTENTS

YOUR SAFETY RESPONSIBILITIES .....	3-6
SAFE STORAGE AND TRANSPORTATION .....	7-8
AMMUNITION .....	9-11
MODEL & FEATURES IDENTIFICATION .....	12-13
INSPECTING THE M&P® FPC™ .....	14-17
PREPARATION FOR FIRING .....	17-18
LOADING THE M&P® FPC™ .....	18-21
FIRING THE M&P® FPC™ .....	21-22
HANGFIRES AND MISFIRES .....	22-24
CLEARING A MISFEED/JAM .....	24-25
UNLOADING THE M&P® FPC™ .....	26
DISASSEMBLY/FIELD STRIPPING .....	27-32
ASSEMBLY .....	32-35
MAGAZINES .....	36-37
INTERCHANGEABLE PALMSWELL GRIP INSERTS .....	38-39
REVERSIBLE MAGAZINE CATCH .....	40-41
M&P® FPC™ IN-STOCK MAGAZINE STORAGE .....	42
FOLDING THE M&P® FPC™ .....	43
INSTALLATION OF OPTICS .....	44
CLEANING AND MAINTENANCE .....	45-47
LIMITED WARRANTY .....	47-49
CONTACT AND SHIPPING INFORMATION .....	49-51
CUSTOM SERVICE, PATENT INFORMATION .....	51
BATTERY WARNINGS .....	52

## YOUR SAFETY RESPONSIBILITIES

### SAFETY IS YOUR NUMBER ONE RESPONSIBILITY!

- At home, in the field, at the range, or anywhere, the first concern of every firearm owner should be safety. Apply the following safety rules in every situation, with any kind of firearm. If you feel uncertain about any operational aspects of your firearm, please contact Smith & Wesson® at 1-800-331-0852, ext. 4125 before proceeding with its operation.
- If you are unfamiliar with firearms you should seek formal training before using your firearm.



**WARNING: YOU MUST FOLLOW ALL OF THESE SAFETY RULES TO ENSURE THE SAFE USE OF YOUR FIREARM. THE FAILURE TO FOLLOW THE INSTRUCTIONS AND WARNINGS IN THIS MANUAL COULD CAUSE PERSONAL INJURY OR DEATH TO YOU OR OTHERS AND DAMAGE TO PROPERTY.**

- As a firearm owner, you accept a demanding responsibility. How seriously you take this responsibility can be the difference between life and death. There is no excuse for careless or abusive handling of your firearm. At all times handle your firearm with intense respect for its power and potential danger.

---

## YOUR SAFETY RESPONSIBILITIES - CONTINUED

---

- **ALWAYS KEEP YOUR FIREARM POINTED IN A SAFE DIRECTION.** Never point a firearm at anyone or anything you do not intend to shoot whether or not it is loaded. This is particularly important when loading, unloading, or field stripping the firearm. ALWAYS control the direction of the firearm.
- **ALWAYS TREAT EVERY FIREARM AS IF IT IS LOADED AND WILL FIRE.** Do not take anyone's word that the firearm is unloaded – always check for yourself. Never pass your firearm to another person until the cylinder or action is open and you visually check that it is unloaded. Keep your firearm unloaded and safely stored when not in use.
- **NEVER PLACE YOUR FINGER INSIDE THE TRIGGER GUARD OR ON THE TRIGGER UNLESS YOU INTEND TO FIRE.** Ensure that other objects do not touch the trigger.
- **ALWAYS BE SURE OF YOUR TARGET AND WHAT IS BEYOND IT.** Always be sure of where the bullet will strike and shoot only where there is a safe back stop free of obstructions, water or other surfaces which can cause a ricochet. Be sure your bullet will stop behind your target. Bullets can glance off many surfaces like rocks or the surface of water and travel in unpredictable directions with considerable velocity. Do not fire randomly into the sky.
- **NEVER CROSS OBSTACLES SUCH AS FENCES OR STREAMS WITH A LOADED FIREARM.** Always make certain your firearm is unloaded before crossing a fence, climbing a tree, jumping a ditch or negotiating other obstacles.
- **SAFE FIREARM HANDLING IS YOUR PERSONAL RESPONSIBILITY AT ALL TIMES.** Firearms are dangerous and can cause injury or death if they are misused or used inappropriately. Safety must be the prime consideration of any one who owns or handles firearms. Accidents are the result of violating the rules of safe firearm handling and common sense. Firearm safety training is available. Contact your firearms dealer, law enforcement agency, local sportsman's club, etc. for availability.
- **YOU ARE RESPONSIBLE FOR THE FIREARM AT ALL TIMES.** In owning a firearm, you must undertake full-time responsibility for your firearm's safety and security. You must protect yourself and all others against injury or death from misuse of the firearm 24 hours a day.
- **FIREARM SECURITY IS YOUR RESPONSIBILITY.** You must secure firearms safely from children and/or unauthorized users. Your firearm should always be kept unloaded and locked when not in use. A lock has been provided for this purpose. Never assume that the use of this lock is sufficient to safely secure your firearm. You must always evaluate your personal situation and employ the security systems that meet your needs and prevent children and unauthorized users from gaining access to your firearm.

---

## YOUR SAFETY RESPONSIBILITIES - CONTINUED

---

- **APPROPRIATE USE FOR YOUR FIREARM MEANS USING YOUR FIREARM FOR LEGAL PURPOSES.** For example - target shooting, hunting and lawful resistance of deadly criminal force. It is your responsibility to ensure that you are in compliance with all applicable laws and ordinances regarding the use of your firearm.
- **NEVER RELY ON MECHANICAL FEATURES ALONE.** Only your safe firearm-handling habits will ensure the safe use of your firearm. This is your responsibility.
- **ALWAYS SAFELY STORE AND SECURE YOUR FIREARM.** Safe and secure storage of your firearm is one of your most important responsibilities. It is a full-time responsibility. You must always secure your firearm and ammunition separately so that they are not accessible to children and/or other unauthorized persons.
- **NEVER KEEP AMMUNITION IN THE SAME LOCATION AS THE FIREARM.** Store each in a separate and secure place.
- **ALWAYS WEAR EYE PROTECTION THAT IS SPECIFIED FOR USE WITH FIREARMS EVERY TIME YOU HANDLE YOUR FIREARM FOR CLEANING AND MAINTENANCE.**
- **ALWAYS WEAR EYE AND HEARING PROTECTION THAT ARE SPECIFIED FOR USE WITH FIREARMS EVERY TIME YOU DISCHARGE YOUR FIREARM.** Make sure others in the vicinity of where you will be shooting do so as well.
- **NEVER USE ALCOHOL OR DRUGS BEFORE OR WHILE SHOOTING.** Do not use your firearm if you are on any medication which impairs, even slightly, your mental or physical ability.
- **ALWAYS HAVE ADEQUATE VENTILATION.** Discharging firearms in poorly ventilated areas, cleaning firearms, or handling ammunition may result in exposure to lead and other substances known to cause birth defects, reproductive harm, and other physical injury. Review the warnings and labels for all ammunition and cleaning products carefully. Wash hands thoroughly after exposure.
- **BEFORE HANDLING ANY FIREARM, UNDERSTAND ITS OPERATION.** Not all firearms are the same. Familiarize yourself with the mechanical features of any firearm you intend to use. If you feel uncertain about any operational aspects of your firearm, please contact Smith & Wesson® at 1-800-331-0852, ext. 4125 before proceeding with its operation.
- **NEVER ALLOW A FIREARM TO BE USED BY ANY INDIVIDUAL WHO DOES NOT UNDERSTAND ITS SAFE OPERATION OR HAS NOT READ THIS SAFETY AND INSTRUCTION MANUAL.**

---

## YOUR SAFETY RESPONSIBILITIES - CONTINUED

---

- **ALWAYS USE THE CORRECT AMMUNITION FOR YOUR PARTICULAR FIREARM AS INDICATED BY THE MARKING ON THE FIREARM.** Never use non-standard, reloaded, or “handloaded” ammunition which has not been subjected to internal ballistic pressure testing.
- **BEWARE OF BARREL BORE OBSTRUCTIONS.** Be sure the barrel bore is clear of obstructions before shooting. Mud, water, snow, or other objects may inadvertently lodge in the barrel bore. A small obstruction can cause a dangerous increase in pressure and cause injury to yourself and others and may damage your gun.
- **BE SURE ALL HOLSTERS, GRIPS, AND OTHER ACCESSORIES ARE COMPATIBLE WITH THE FIREARM AND THAT THE ACCESSORIES DO NOT INTERFERE WITH SAFE OPERATION.** It is your responsibility to understand and follow all of the instructions in this manual, as well as those which may be supplied with your ammunition and any accessory.
- **NEVER DISASSEMBLE YOUR FIREARM BEYOND THE FIELD STRIPPING PROCEDURE OUTLINED IN THIS MANUAL.** Improper disassembly or reassembly of your firearm may be dangerous and can lead to injury or death.
- **NEVER MANIPULATE, ADJUST OR CHANGE ANY OF THE INTERNAL COMPONENTS OF YOUR FIREARM UNLESS SPECIFICALLY INSTRUCTED TO DO SO IN THIS MANUAL.** Improper manipulation of any internal component may affect the safety and reliability of your firearm and may cause injury or death.
- **NEVER ALLOW ANY ALTERATION OR REPLACEMENT OF PARTS IN YOUR SMITH & WESSON® FIREARM UNLESS PERFORMED BY A QUALIFIED GUNSMITH USING GENUINE SMITH & WESSON® PARTS.** If you do otherwise, improper functioning of your firearm may occur and injury or death and damage to property may result.



**WARNING: SAFE USE OF A FIREARM IS YOUR PERSONAL RESPONSIBILITY AND THE FAILURE TO FOLLOW ALL OF THESE BASIC SAFETY RULES MAY RESULT IN SEVERE PERSONAL INJURY OR DEATH TO YOU OR OTHERS AND DAMAGE TO PROPERTY. YOU ARE THE MOST IMPORTANT SAFETY DEVICE WHEN IT COMES TO THE USE OF YOUR FIREARM AND SMITH & WESSON® WILL NOT BE RESPONSIBLE FOR ANY PERSONAL INJURY, DEATH OR PROPERTY DAMAGE THAT RESULTS FROM: (1) THE CRIMINAL OR NEGLIGENT USE OF THIS FIREARM; (2) A DISREGARD OF THESE SAFETY INSTRUCTIONS AND WARNINGS; (3) IMPROPER OR CARELESS HANDLING OF THIS FIREARM; (4) THE USE OF NON-STANDARD, DEFECTIVE OR IMPROPER AMMUNITION OR; (5) IMPROPER OR NEGLIGENT MODIFICATIONS OR REPAIRS TO THE FIREARM.**

# SAFE STORAGE AND TRANSPORTATION



**WARNING: ALWAYS KEEP THE MUZZLE OF THE FIREARM POINTED IN A SAFE DIRECTION.**



**WARNING: FIREARMS ARE DANGEROUS WHEN USED AND STORED IMPROPERLY. THEY POSE A RISK OF SERIOUS OR FATAL INJURIES. FIREARMS CAN BE ESPECIALLY DANGEROUS TO CHILDREN WHEN THEY ARE STORED IN AN IRRESPONSIBLE AND UNSAFE MANNER. FOR YOUR SAFETY AND THE SAFETY OF OTHERS, IT IS IMPERATIVE THAT YOU KEEP YOUR FIREARM LOCKED AND UNLOADED IN A SECURE PLACE. THE AMMUNITION SHOULD BE STORED IN A SEPARATE, SECURE LOCATION WHEN IT IS NOT IN USE. SAFE AND SECURE STORAGE OF YOUR FIREARM IS ONE OF THE MOST IMPORTANT RULES OF FIREARM SAFETY. YOUR FAILURE TO FOLLOW THESE RULES MAY RESULT IN INJURY OR DEATH TO YOU OR OTHERS.**

- **ALWAYS SECURE YOUR FIREARM IN A MANNER THAT WILL PREVENT UNAUTHORIZED ACCESS.** Whenever your firearm is not in use, keep it unloaded and locked. Your safety and the safety of others requires that you always secure and store your firearm in a manner that will prevent unauthorized access. Never leave a firearm unattended unless it is locked, unloaded and secured.
- **ALWAYS USE THE LOCK PROVIDED BY SMITH & WESSON® TO SECURE YOUR FIREARM.** Please read and follow the instructions packaged separately for the use of this lock. A lock, when properly used, can be an effective tool in preventing unauthorized access to your firearm. There are other alternative locks and safe storage containers available in the marketplace which may also be appropriate for your particular needs. Consult your local firearm shop, hardware store, or local police department for guidance on the variety of other safe storage devices or practices which may be appropriate for your particular needs. By purchasing this firearm you have accepted the responsibility of safely securing the firearm at all times and preventing its unauthorized use. Never assume that the use of this lock alone is sufficient to safely secure your firearm. It is your personal responsibility to select and use whatever measures or practices that will enable you to be absolutely certain that your firearm is secure at all times.



**WARNING: NEVER LOCK A LOADED FIREARM AND NEVER LOAD A LOCKED FIREARM!**

- **ALWAYS STORE YOUR FIREARM AND AMMUNITION SEPARATELY SO THAT THEY ARE NOT ACCESSIBLE TO CHILDREN OR OTHER UNAUTHORIZED PERSONS.** Safe and secure storage of your firearm and ammunition are your responsibility. It is a full-time responsibility.

---

## SAFE STORAGE AND TRANSPORTATION - CONTINUED

---

- **NEVER ASSUME THAT A “HIDING” PLACE IS A SECURE STORAGE METHOD.** Others may be aware of your storage location or come upon it by chance. It is your personal responsibility to use common sense when storing your firearm and ammunition and to always make sure they are not accessible to children or other unauthorized persons.
- **NEVER TRANSPORT A LOADED FIREARM.** When transporting your firearm, be sure it is unloaded and locked. Safe and secure transportation of your firearm is your responsibility.
- **ALWAYS FOLLOW THE LAW!** Many jurisdictions have laws that make it a crime to keep a firearm unlocked and in an area accessible to children or others. Keeping a firearm locked and unloaded when not in use is not only common sense safety practice... IT IS THE LAW. You must be familiar with all local, state, and federal laws regarding the safe storage and transportation of your firearm. Failure to know and follow the law may result in unauthorized access or use of your firearm by another. Obey all laws relating to the storage and transportation of firearms. Your local police department or firearm shop can furnish you with available information on storing and/or transporting a firearm safely and legally.
- **YOUR FIREARM IS YOUR RESPONSIBILITY.** You must prevent your firearm from being stolen or from being used by untrained or unqualified individuals. Keep it locked, unloaded and secured when not in use.
- Never leave the key with the stored firearm.



## AMMUNITION



**WARNING: NEVER USE AMMUNITION NOT SPECIFICALLY DESIGNATED FOR USE IN YOUR FIREARM. FAILURE TO USE THE CORRECT TYPE OR CALIBER OF AMMUNITION MAY CAUSE THE FIREARM TO JAM, FAIL TO FIRE, OR MAY GENERATE EXCESSIVE PRESSURE WHICH CAN DAMAGE OR EVEN RUPTURE YOUR FIREARM, CAUSING PERSONAL INJURY OR DEATH TO THE SHOOTER OR BYSTANDERS.**

- This firearm model is offered in multiple calibers. Locate the cartridge designation marked on the firearm's barrel. This information indicates the correct ammunition that must be used in your firearm (FIGURES 1a & 1b).

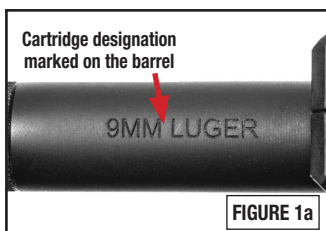

- You are responsible for selecting ammunition that meets industry standards and is appropriate in type and caliber for this firearm.

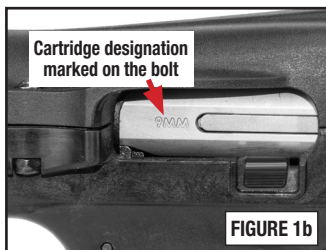

- Never mix ammunition.



**WARNING: IN SOME CASES, A ROUND OF AMMUNITION NOT SPECIFIED ON YOUR FIREARM AND NOT LISTED AS ALTERNATE AMMUNITION IN THIS MANUAL MAY FIT INTO THE CHAMBER. FIRING THIS AMMUNITION MAY CAUSE A RUPTURE, RESULTING IN PERSONAL INJURY OR DEATH TO THE SHOOTER AND/OR BYSTANDERS AND DAMAGE TO PROPERTY. FOR MORE INFORMATION REGARDING UNSAFE CALIBER COMBINATIONS, REFER TO THE AMERICAN NATIONAL STANDARDS PUBLISHED BY SPORTING ARMS AND AMMUNITION MANUFACTURERS' INSTITUTE (SAAMI) AT [HTTPS://SAAMI.ORG](https://saami.org)**



**WARNING: ALWAYS INSPECT YOUR AMMUNITION BEFORE USING IT. NEVER USE DIRTY, CORRODED OR DAMAGED AMMUNITION. A BURST CARTRIDGE OR BORE OBSTRUCTION MAY RESULT CAUSING DAMAGE TO THE FIREARM AND PERSONAL INJURY OR DEATH TO THE SHOOTER AND/OR BYSTANDERS.**



**WARNING: NEVER USE AMMUNITION OF THE INCORRECT GAUGE OR CALIBER. USING AMMUNITION OF THE INCORRECT GAUGE OR CALIBER MAY CAUSE DAMAGE TO YOUR FIREARM AND POSSIBLE INJURY TO YOU AND TO OTHERS.**

---

## AMMUNITION - CONTINUED

---



**WARNING: DISCHARGING FIREARMS IN POORLY VENTILATED AREAS, CLEANING FIREARMS, OR HANDLING AMMUNITION MAY RESULT IN EXPOSURE TO LEAD AND OTHER SUBSTANCES KNOWN TO CAUSE BIRTH DEFECTS, REPRODUCTIVE HARM AND OTHER PHYSICAL INJURY. HAVE ADEQUATE VENTILATION AT ALL TIMES. WASH HANDS THOROUGHLY AFTER EXPOSURE.**



**WARNING: NEVER USE NON-STANDARD, RELOADED OR "HANDLOADED" AMMUNITION WHICH HAS NOT BEEN SUBJECTED TO INTERNAL BALLISTIC PRESSURE TESTING. RELOADED OR HANDLOADED AMMUNITION, MAY HAVE MANY MANUFACTURING AND QUALITY VARIABLES (SUCH AS THE TYPE AND AMOUNT OF GUN POWDER). CARTRIDGE CASES THAT HAVE BEEN RELOADED AND FIRED MULTIPLE TIMES MAY SUFFER PHYSICAL DAMAGE WHICH COULD SIGNIFICANTLY IMPACT OR REDUCE THE INTEGRITY OF THE CARTRIDGE, POSSIBLY RESULTING IN BULLET SETBACK OR UNSEATING. CASE FAILURE AND INJURY TO THE SHOOTER OR BYSTANDERS AND DAMAGE TO THE FIREARM MAY RESULT WHEN SUCH A ROUND IS FIRED. ANY AMMUNITION THAT IS IMPROPERLY MANUFACTURED OR RELOADED, EVEN IN THE SLIGHTEST DEGREE, MAY FAIL TO FIRE OR MAY GENERATE EXCESSIVE INTERNAL PRESSURES WHICH CAN DAMAGE OR EVEN RUPTURE THE FIREARM, CAUSING PERSONAL INJURY OR DEATH TO THE SHOOTER OR THOSE IN THE IMMEDIATE VICINITY.**



**WARNING: NEVER USE CARTRIDGES OTHER THAN THOSE DESIGNATED BY THE MARKING ON THE FIREARM UNLESS SPECIFIED IN THIS MANUAL. DOING SO MAY CAUSE INJURY OR DEATH TO THE SHOOTER OR BYSTANDERS AND DAMAGE TO PROPERTY.**



**WARNING: NEVER APPLY LUBRICANTS OR CLEANER DIRECTLY ONTO AMMUNITION. APPLYING LUBRICANT OR CLEANER TO AMMUNITION CAN CONTAMINATE THE AMMUNITION AND RESULT IN A SQUIB LOAD. A SQUIB LOAD CAN RESULT IN A BORE OBSTRUCTION WHEN THE BULLET BECOMES LODGED IN THE BORE. INJURY OR DEATH TO THE SHOOTER OR BYSTANDERS AND DAMAGE TO PROPERTY COULD RESULT WHEN A SUBSEQUENT ROUND IS FIRED.**

- A firearm and ammunition are a system and must work together. There are different types of ammunition for different types of firearms. Your firearm has been designed for ammunition of a specific type and a specific gauge or caliber. It is important to select the proper ammunition for your firearm.

## AMMUNITION - CONTINUED

- Different combinations of bullet velocity, bullet weight and firearm weight can have major impact on felt recoil; high felt recoil can be uncomfortable to some shooters.
- “Plus-P” (+P) ammunition generates pressures in excess of the pressures associated with standard ammunition. Such pressures may affect the wear characteristics and may result in the need for more frequent service.
- “Plus-P-Plus” (+P+) ammunition must NOT be used in Smith & Wesson® firearms. This marking on the ammunition designates that it exceeds established industry standards, but the designation does not represent defined pressure limits and therefore such ammunition may vary significantly as to the pressures generated and could be DANGEROUS.

Marking on Firearm	Ammunition Type		
	Standard	+P	+P+
5.7x28mm	OK	NO	NO
30 SUPER CARRY™	OK	NO	NO
380 AUTO	OK	NO	NO
9mm Luger	OK	OK	NO
9x21mm	OK	NO	NO
38 Super	OK	OK	NO
357 SIG	OK	NO	NO
40 S&W	OK	NO	NO
10mm AUTO	OK	NO	NO
45 AUTO	OK	OK	NO

- Some brands of ammunition may cause difficulty in extracting spent cartridge cases from the chamber. If this situation occurs, thoroughly clean the chamber with solvent. If this condition persists, we recommend changing to another brand of ammunition.

# MODEL & FEATURES IDENTIFICATION

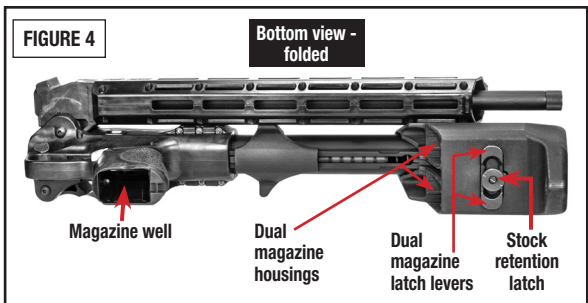
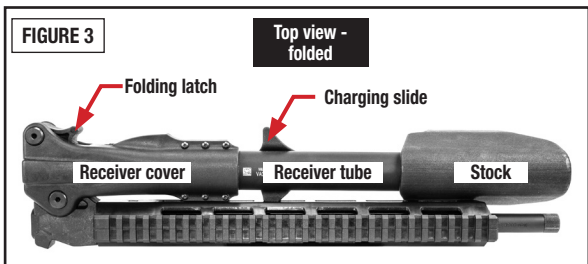
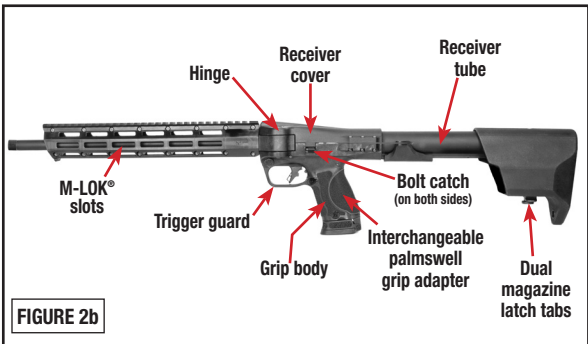
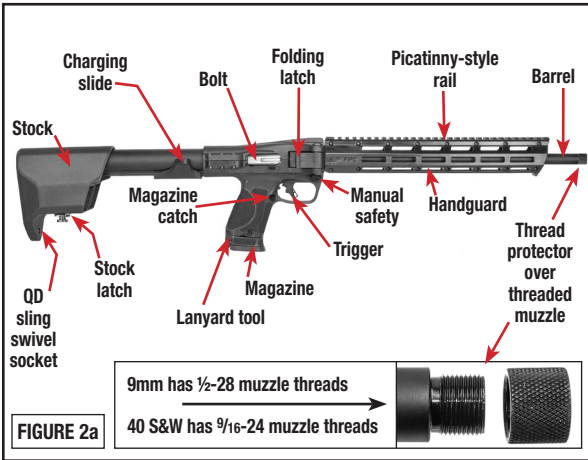

## MODEL & FEATURES IDENTIFICATION - CONTINUED

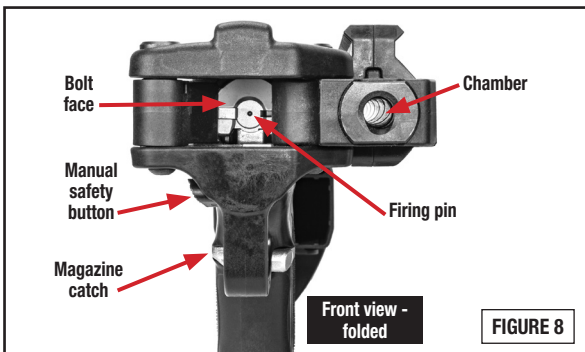
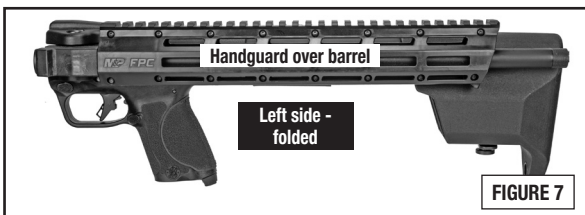
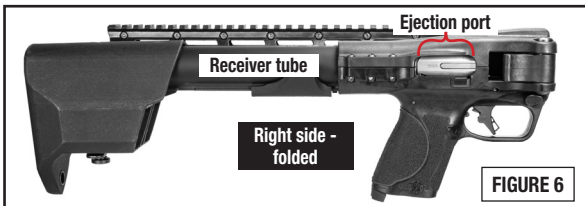
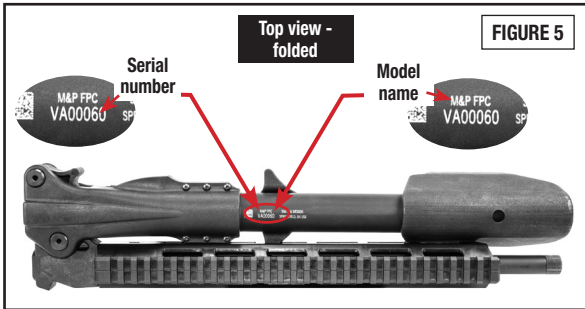

## INSPECTING THE M&P® FPC™



**WARNING: ALWAYS ENSURE THAT THE FIREARM IS UNLOADED BEFORE INSPECTING, FOLDING, UNFOLDING, DISASSEMBLING, ASSEMBLING, CLEANING, ADDING OR REMOVING ACCESSORIES, AND ALWAYS KEEP THE MUZZLE POINTED IN A SAFE DIRECTION.**



**WARNING: NEVER RELY ON MECHANICAL FEATURES ALONE. ONLY YOUR SAFE FIREARM HANDLING WILL ENSURE THE SAFE USE OF YOUR FIREARM. THIS IS YOUR RESPONSIBILITY.**



**WARNING: REMOVING THE MAGAZINE FROM THE M&P® FPC™ DOES NOT UNLOAD THE CHAMBER. THE M&P® FPC™ CAN FIRE WITH THE MAGAZINE REMOVED, IF A ROUND HAS BEEN CHAMBERED AND THE MANUAL THUMB SAFETY IS PLACED IN THE “FIRE” POSITION AND THE TRIGGER IS THEN PULLED.**



**WARNING: BE CAREFUL WHEN FOLDING OR UNFOLDING THE M&P® FPC™ TO AVOID PINCH POINTS.**

- When you inspect your firearm, you must check for yourself that it is unloaded. To do this, grasp the M&P® FPC™ with your finger off the trigger and outside the trigger guard, point the muzzle in a safe direction.
- As shipped from the factory, the M&P® FPC™ is folded. The M&P® FPC™ is held in the folded position by the notch in the charging slide engaging a slot in the handguard (FIGURE 16).
- Press the magazine catch and remove the magazine from the M&P® FPC™ (FIGURE 10).
- Verify that the chamber is empty and that the bore is clear of obstructions (FIGURE 11). If any obstruction is observed, remove it from the bore before proceeding

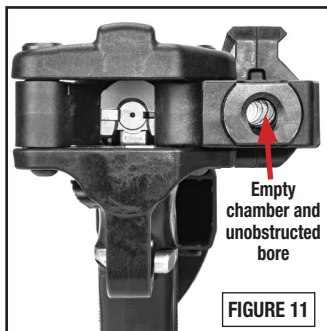

## INSPECTING THE M&P® FPC™ - CONTINUED

- Press the manual safety button fully to the “SAFE” position. (FIGURES 12 through 15) show the manual safety in the “SAFE” and “FIRE” positions - from the front and from the bottom.

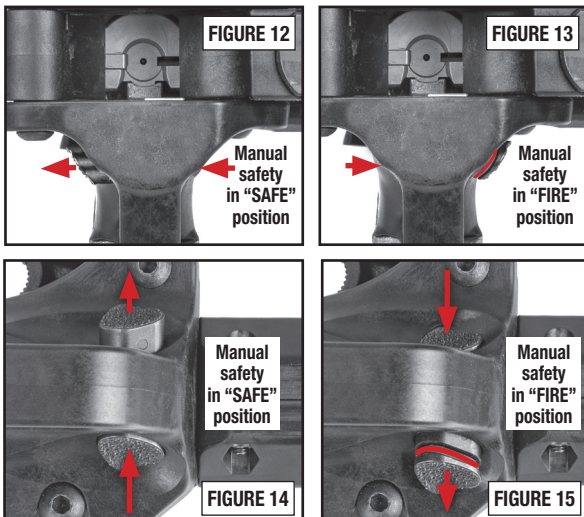

- To open the M&P® FPC™ from its folded state, the user must draw the charging slide slightly to the rear to unlock it from the handguard (FIGURE 16) and then swing the barrel away from the receiver tube (FIGURE 17).

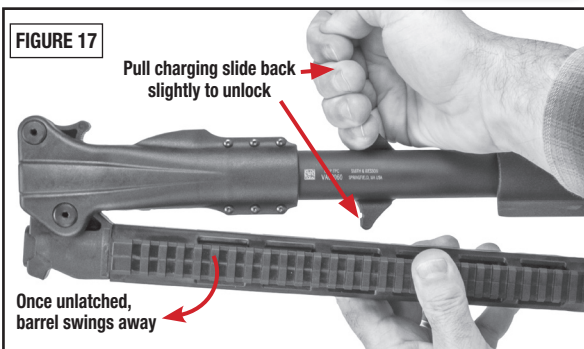
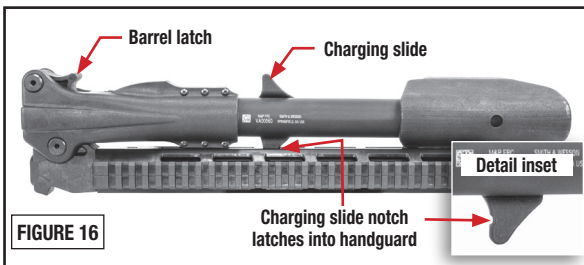

## INSPECTING THE M&P® FPC™ - CONTINUED

- Continue to swing the barrel until the barrel latch “snaps” into position (FIGURE 18).

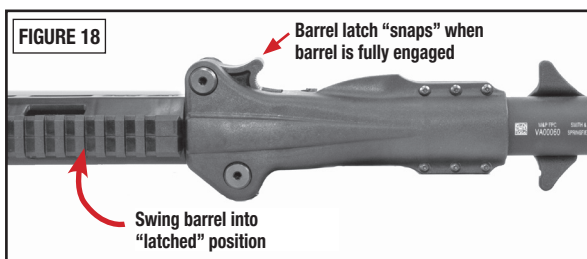

- Pull the charging slide all the way back and then press the bolt catch up. Let the bolt move forward against the bolt catch to hold the bolt in the open position (FIGURE 19). Remove your fingers from the bolt catch. Return the charging slide fully forward until it “clicks” into its forward position.

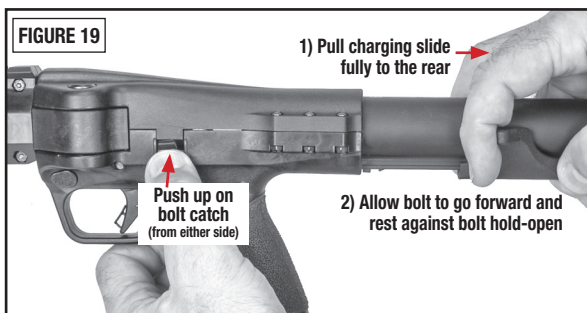

- Look into the receiver and check the chamber and magazine well to ensure that no cartridges are present (FIGURE 20).

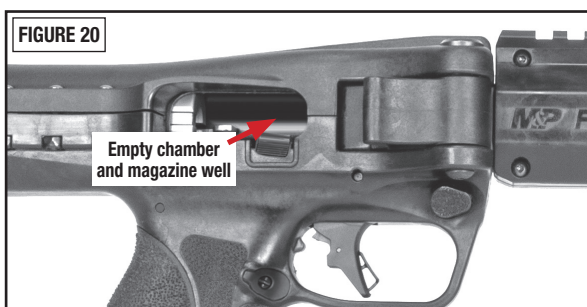

- You must follow this procedure every time a firearm leaves your hand, is cleaned, handed to you or another person, transported or stored.



---

## INSPECTING THE M&P® FPC™ - CONTINUED

---

- If the magazine contains any cartridges, unload it by holding it with the bullet end of the cartridge pointing away from you and others and pressing each cartridge forward and out of the magazine (FIGURE 21).
- Before using your firearm for the first time, it should be cleaned. See the Cleaning Section of this manual.



---

## PREPARATION FOR FIRING

---



**WARNING: FAILURE TO FOLLOW THESE FIREARM SAFETY REQUIREMENTS MAY RESULT IN PERSONAL INJURY OR DEATH TO YOU OR OTHERS AND DAMAGE TO PROPERTY.**

- **ALWAYS TREAT ALL FIREARMS AS IF THEY ARE LOADED.**
- **ALWAYS BE SURE THAT THE CHAMBER IS EMPTY AND THE MAGAZINE HAS BEEN REMOVED OR UNLOADED, AND THAT THE FIREARM IS POINTING IN A SAFE DIRECTION.**
- **ALWAYS BE SURE THAT THE BORE IS CLEAR AND THE NO OBSTRUCTION IS PRESENT IN THE BORE PRIOR TO LOADING AND FIRING.**
- **ALWAYS KEEP FINGERS AND OTHER BODY PARTS AWAY FROM THE MUZZLE AND AWAY FROM THE EJECTION PORT.**
- **ALWAYS WEAR ADEQUATE AND PROPER HEARING PROTECTION SPECIFIED FOR FIREARM USE.** To prevent permanent damage to your hearing, you must always use hearing protection. Make sure others who are nearby are wearing hearing protection as well.
- **ALWAYS WEAR SAFETY GLASSES SPECIFIED FOR FIREARM USE.** Whether indoors or out, safety glasses should protect your eyes from the firing flash and particles associated with the discharge of ammunition. Failure to do so creates a risk of personal injury from particle or debris spitting or a ricochet.
- **ALWAYS BE ALERT AND ALWAYS FOLLOW THE SAFETY INSTRUCTIONS OF THE RANGE OFFICER.** Never shoot if you are tired, cold, or otherwise impaired in any way.

---

## PREPARATION FOR FIRING - CONTINUED

---

- **ALWAYS BE AWARE OF OTHER PEOPLE.** Be aware of others to ensure that persons do not accidentally walk into the line of fire.
- **THE SHOOTER (AND ALL OTHERS IN THE SHOOTING AREA) MUST ALWAYS BE IN A POSITION THAT IS OUT OF THE LINE OF FIRE AND NOT WITHIN AN AREA WHERE THEY MAY BE STRUCK BY A RICOCHET, OR PARTICLES SPITTING FROM A FIREARM, OR BY EJECTED CASES FROM THE FIREARM.**
- **NEVER SHOOT AT SURFACES THAT MAY CAUSE A RICOCHET.**  
Always select a place to shoot that has a safe backstop, is free from obstructions, and has no surfaces which may cause a ricochet.
- **NEVER FIRE RANDOMLY INTO THE SKY.** Always select a place to shoot that has a safe backstop.
- **NEVER USE ALCOHOL OR DRUGS BEFORE OR WHILE SHOOTING OR HANDLING ANY FIREARM.**

---

## LOADING THE M&P® FPC™

---



**WARNING: ALWAYS KEEP THE MUZZLE OF THE FIREARM POINTED IN A SAFE DIRECTION.**



**WARNING: NEVER RELY ON MECHANICAL FEATURES ALONE. ONLY YOUR SAFE FIREARM HANDLING WILL ENSURE THE SAFE USE OF YOUR FIREARM. THIS IS YOUR RESPONSIBILITY.**

- Do not load the M&P® FPC™ until you have read and fully understand this manual.
- Do not load the M&P® FPC™ until you are ready to use it. Keep your finger off the trigger and outside the trigger guard until you are ready to fire.
- Never load your M&P® FPC™ until you are sure of your target, what is beyond it and are fully prepared to fire.
- Press the magazine catch and remove the magazine from the firearm (FIGURE 22).



## LOADING - CONTINUED

- Set the manual safety button to the “SAFE” position (FIGURE 23).
- Pull the charging slide all the way back and then press the bolt catch up. Let the bolt move forward against the bolt catch to hold the bolt in the open position (FIGURE 24). Remove your fingers from the bolt catch. Return the charging slide fully forward until it “clicks” into its forward position.

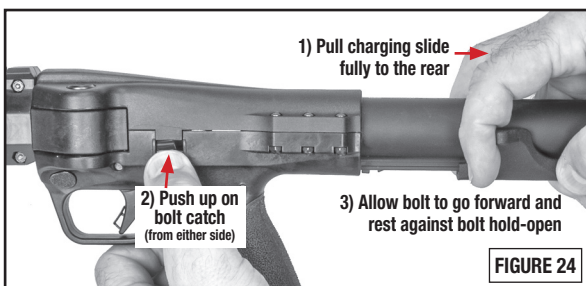
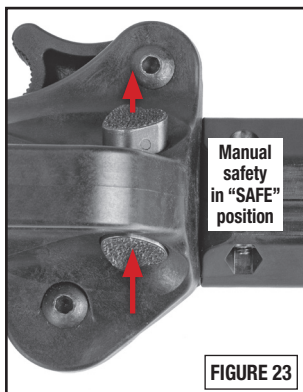

- Orient the magazine as shown (FIGURE 25). Place a round between the lips of the magazine with the bullet forward. Press the round down and back until it is held by the magazine lips. Slide the next round in on top of the previous round and repeat until the desired number is loaded.

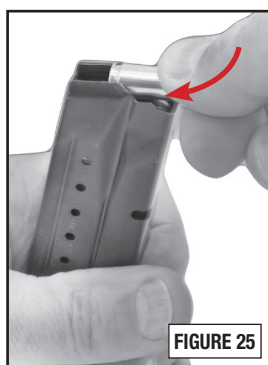

**NOTE:** The M&P® FPC™ accepts most of the magazines (in the same caliber as your FPC™) that also fit the double-stack M&P® and M&P® M2.0™ pistols from Smith & Wesson®.

- Smith & Wesson® has provided you with magazine(s) designed to operate in your specific model and caliber of FPC™. While the magazine may be able to be inserted into another model firearm, it will function properly only in the specific model(s) for which it was designed.

## LOADING - CONTINUED

- With the bullet end of the cartridge pointing forward (FIGURE 26), insert the loaded magazine into the magazine well until it is locked securely in place. Check retention by putting some downward pressure on magazine floor plate.

FIGURE 26



- Keep the muzzle pointing in a safe direction. Grasp the charging slide and draw it rearward to disengage the bolt catch (FIGURE 27a). Once the bolt catch disengages, release the charging slide and allow the bolt to move forward freely (FIGURE 27b). This will feed a round from the magazine into the chamber. The firearm is now loaded and will fire if the manual safety button is set to “FIRE” and the trigger is pulled.

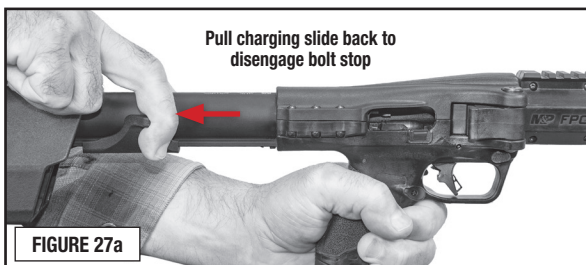

FIGURE 27a



FIGURE 27b



**WARNING: ALWAYS POINT THE MUZZLE IN A SAFE DIRECTION WHEN YOU RELEASE THE BOLT.**



**WARNING: IF THE CARTRIDGE FAILS TO STRIP FROM THE MAGAZINE OR FULLY SEAT INTO THE CHAMBER, IMMEDIATELY STOP THE LOADING PROCESS. PLACE THE SAFETY IN THE “SAFE” POSITION, REMOVE THE MAGAZINE, LOCK THE ACTION OPEN, AND VERIFY THAT THE CHAMBER IS EMPTY. REFER TO THE “INSPECTING YOUR FIREARM” SECTION OF THIS MANUAL.**



**WARNING: ALWAYS LOAD A ROUND INTO THE CHAMBER BY FEEDING IT FROM THE MAGAZINE. NEVER ATTEMPT TO LOAD THE FIREARM BY INSERTING A ROUND INTO THE OPEN EJECTION PORT. FAILURE TO FOLLOW THIS WARNING CAN RESULT IN SEVERE INJURY OR DEATH TO YOUR OR OTHERS.**

## LOADING - CONTINUED



**WARNING: M&P® FPC™ WILL FIRE WITH THE MAGAZINE REMOVED FROM THE FIREARM. KEEP YOUR FINGER OFF THE TRIGGER AND OUTSIDE THE TRIGGER GUARD UNTIL YOU HAVE MADE THE COMMITMENT TO FIRE.**

## FIRING THE M&P® FPC™



**WARNING: ALWAYS KEEP THE MUZZLE OF THE FIREARM POINTED IN A SAFE DIRECTION.**



**WARNING: WEAR EYE AND HEARING PROTECTION SPECIFIED FOR FIREARM USE EVERY TIME YOU DISCHARGE YOUR FIREARM. MAKE SURE OTHERS IN THE VICINITY OF WHERE YOU WILL BE SHOOTING DO SO AS WELL.**



**WARNING: MAINTAIN ADEQUATE CLEARANCE BETWEEN THE OPERATOR'S FACE AND CHARGING SLIDE HANDLE DURING FIRING. THE CHARGING SLIDE HANDLE MAY CONTACT A USER'S FACE AND CAUSE INJURY DURING RECOIL IF ADEQUATE CLEARANCE AND A FIRM GRIP ARE NOT MAINTAINED.**

- Grasp the firearm with one hand on handguard and the other hand on the grip with your trigger finger resting along the outside of trigger guard. Raise the firearm and pull the butt stock firmly into your shoulder (FIGURE 28).



- Push the manual safety button to the "FIRE" position (FIGURE 29).
- Keeping steady aim, place index finger on trigger and pull gently until the M&P® FPC™ fires. Your firearm chambers the next round immediately after firing.

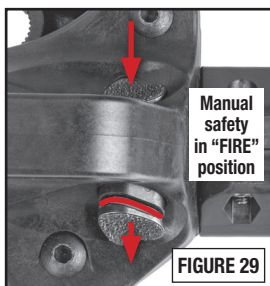

- You may continue to fire by pulling and fully releasing the trigger (between shots) until the magazine is empty.

## FIRING THE M&P® FPC™ - CONTINUED

- If you wish to stop firing, release trigger, remove your finger from the trigger guard and push the manual safety button to the “SAFE” position (FIGURE 30).
- If you have fired the last round from the magazine, the bolt will be held to the rear so that the firearm can be reloaded by replacing the magazine, or the chamber can be inspected to ensure that it is empty (FIGURE 31).

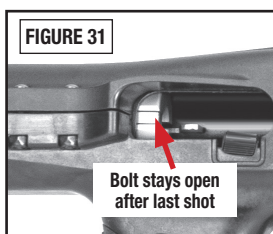
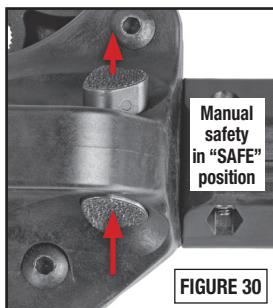

## HANGFIRES AND MISFIRES



**WARNING: ALWAYS KEEP THE MUZZLE OF THE FIREARM POINTED IN A SAFE DIRECTION.**



**WARNING: WEAR EYE AND HEARING PROTECTION SPECIFIED FOR USE WITH FIREARMS WHEN FIRING AND WHEN CLEARING MISFIRES OR MISFEEDS.**



**WARNING: KEEP YOUR FACE A SAFE DISTANCE FROM THE EJECTION PORT WHEN CLEARING A CARTRIDGE. IF A CARTRIDGE IGNITES WHILE BEING CLEARED FROM THE FIREARM, INJURY OR DEATH MAY RESULT.**



**WARNING: IF YOUR FIREARM GIVES ANY INDICATION THAT IT IS NOT PERFORMING PROPERLY OR THE OPERATION OF YOUR FIREARM HAS CHANGED “THE WAY IT FEELS OR SOUNDS”, STOP FIRING. MAKE SURE THE FIREARM IS POINTED IN A SAFE DIRECTION, UNLOAD THE FIREARM AND HAVE IT INSPECTED AND TEST FIRED BY A GUNSMITH QUALIFIED TO PERFORM SERVICES ON SMITH & WESSON® FIREARMS.**

**NOTE:** In the case of either a hangfire or misfire, keep the muzzle pointed in a safe direction and your finger off the trigger.

## HANGFIRES AND MISFIRES - CONTINUED

- Wait 60 seconds, then put the manual safety button into the "SAFE" position (FIGURE 32).
- Press the magazine catch button and remove the magazine from the firearm (FIGURE 33).
- Proceed to clear the unfired cartridge from the chamber.

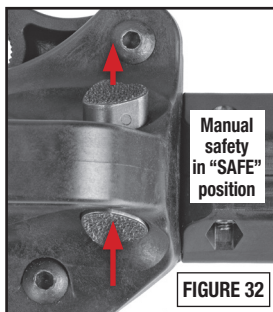

- A **HANGFIRE** is described as a noticeable delay between the impact of the firing pin on the primer of the cartridge and the actual discharge of the firearm. This is generally caused by defective or damaged ammunition.



- If a cartridge has delayed ignition and goes off after a delay, with the firearm pointed in a safe direction, the magazine should be removed and the firearm should be unloaded. The remainder of similar ammunition should be inspected to determine if it has been contaminated or damaged and dealt with accordingly.

- A **MISFIRE** is the failure of the chambered cartridge to fire at all after the trigger has been pulled. This is generally caused by defective or damaged ammunition or a dirty or fouled firearm.
- A light primer strike caused by a dirty or fouled firearm can lead to misfires. If a light indent on the primer of a misfire is noted, unload the firearm and clean it as instructed in the Cleaning and Maintenance Section of this manual. If the cartridge does not go off, the "dud" cartridge needs to be removed from the firearm.

- Push the manual safety button into the "SAFE" position (FIGURE 34).

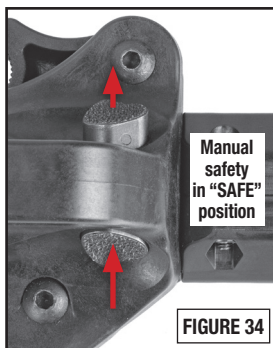

---

## HANGFIRES AND MISFIRES - CONTINUED

---

- Pull the charging slide all the way back (FIGURE 35), then press the bolt catch up (from either side). Let the bolt move forward against the bolt catch to lock the bolt open. Return the charging slide fully forward.

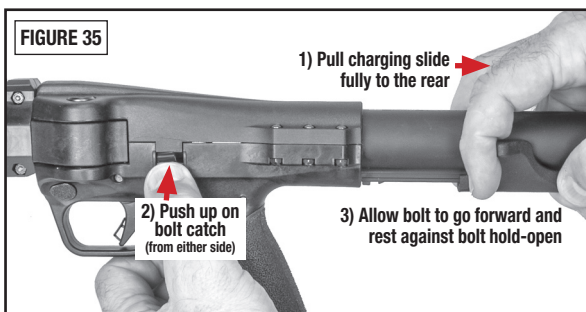

- Visually check the chamber and magazine well to ensure that no cartridges are present (FIGURE 36).
- The firearm should be inspected and cleaned before returning it to use.
- The ammunition should be inspected and damaged or defective rounds should not be used.

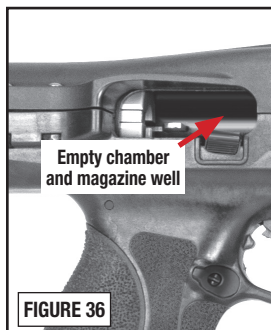

- Damaged or defective ammunition should be disposed of properly.

---

## CLEARING A MISFEED/JAM

---

**NOTE:** Any auto-loading firearm may, on occasion, fail to feed a cartridge properly from the magazine and into the chamber. If this should occur:



**WARNING: KEEP YOUR FACE A SAFE DISTANCE FROM THE EJECTION PORT WHEN CLEARING A MISFED/JAMMED CARTRIDGE. A CARTRIDGE MAY IGNITE IF THE PRIMER OF THE CARTRIDGE IS STRUCK WITH SUFFICIENT FORCE. IF A CARTRIDGE IGNITES WHILE BEING CLEARED FROM THE FIREARM, INJURY OR DEATH MAY RESULT.**



## CLEARING A MISFEED/JAM - CONTINUED

### TO CLEAR A MISFEED (“JAM”)

- Make certain that the muzzle is pointed in a safe direction.
- Push the manual safety button into the “SAFE” position (FIGURE 37).
- Press the magazine catch and remove the magazine from the M&P® FPC™ (FIGURE 38).
- Pull the charging slide back and engage the bolt stop to lock the bolt open (FIGURE 39).

**NOTE:** Drawing the bolt fully to the rear should allow clearance for the jammed cartridge to fall free and clear of the firearm.

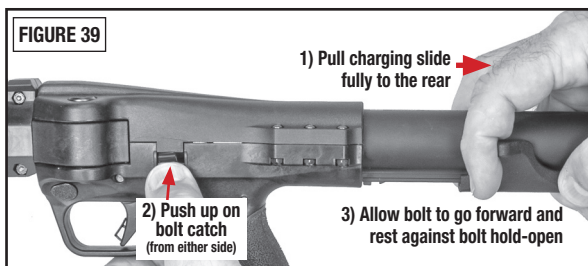
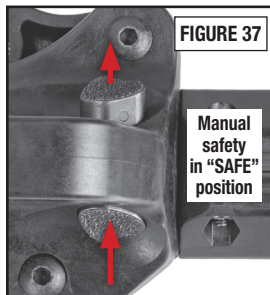

- It may be necessary to manually remove a jammed cartridge. When attempting to clear a jam manually, use only wood “tools”, such as a pointed dowel or a pencil, and use extreme care to avoid striking the primer of the cartridge.
- Visually check to make sure all cartridges have been removed from the firearm chamber and magazine well (FIGURE 40).
- Once the misfed cartridge is cleared, proceed to load the firearm as instructed in the Loading Section of this manual.

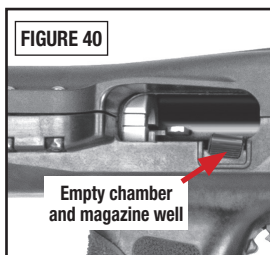

- Dispose of defective cartridge(s) in a method specifically approved for live round disposal.

## UNLOADING THE M&P® FPC™



**WARNING: ALWAYS KEEP THE MUZZLE OF THE FIREARM POINTED IN A SAFE DIRECTION.**

- Push the manual safety button into the “SAFE” position (FIGURE 41).
- Press magazine catch and remove magazine from the M&P® FPC™ (FIGURE 42).
- Pull charging slide fully to the rear and push up on the bolt catch, then let the charging slide move forward slightly until the bolt is held by the bolt catch to hold bolt open (FIGURE 43).
- Return the charging slide fully forward to the closed position.
- Look into the chamber through ejection port to ensure that the chamber and magazine well are empty (FIGURE 44).

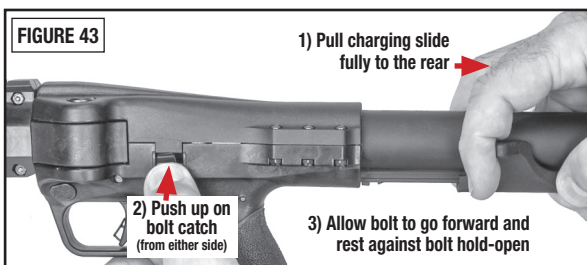
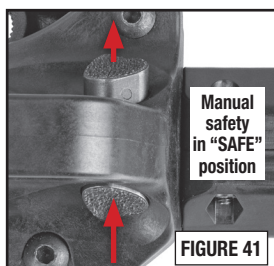

- Remove remaining live rounds from the magazine by sliding them forward and out of the magazine (FIGURE 45).
- Collect live ammunition for safe storage and spent cartridge cases for disposal.

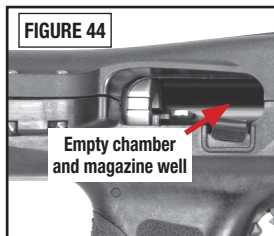

## DISASSEMBLY/FIELD STRIPPING



**WARNING: ALWAYS KEEP THE MUZZLE OF THE FIREARM POINTED IN A SAFE DIRECTION.**



**WARNING: NEVER DO ANYTHING BEYOND WHAT YOU ARE SPECIFICALLY INSTRUCTED TO DO IN THIS MANUAL. NEVER ALTER OR MODIFY THE PARTS IN YOUR FIREARM.**



**WARNING: WEAR SAFETY GLASSES THAT ARE SPECIFIED FOR FIREARMS USE EVERY TIME YOU ASSEMBLE OR DISASSEMBLE YOUR FIREARM.**



**WARNING: ANY MAINTENANCE, ADJUSTMENT OR SERVICE NOT SPECIFIED IN THIS MANUAL MAY AFFECT THE SAFETY AND RELIABILITY OF YOUR FIREARM AND MUST BE PERFORMED BY A QUALIFIED GUNSMITH USING GENUINE SMITH & WESSON® PARTS. IF YOU DO OTHERWISE, IMPROPER FUNCTIONING OF YOUR FIREARM MAY OCCUR AND INJURY OR DEATH AND DAMAGE TO PROPERTY MAY RESULT.**

- Point the muzzle in a safe direction. Make sure your finger is off the trigger and out of the trigger guard. Depress the magazine catch and remove the magazine (FIGURE 46).
- Push the manual safety button into the “SAFE” position (FIGURE 47).
- With the barrel still pointing in a safe direction, and with your finger off the trigger and outside the trigger guard, grasp the charging slide, and while holding the firearm in an upright position, briskly draw the charging slide fully rearward in order to extract any cartridge from the barrel chamber and clear it from the firearm (FIGURE 48).

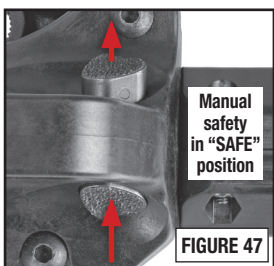

## DISASSEMBLY/FIELD STRIPPING - CONTINUED

- Allow the bolt to close by returning the charging slide fully forward - so the bolt is in the closed position (FIGURE 49).



- Remove any magazine(s) from the in-stock storage cavities.
- Place the butt stock against a stable surface and press down firmly (FIGURE 50). While holding downward pressure on the stock, pull the stock retainer latch out and allow the receiver tube to move upward (against spring pressure) when the stock latch disengages from the receiver tube.
- You can now continue to pull the stock (and its internal buffer spring) off the receiver tube (FIGURE 51).

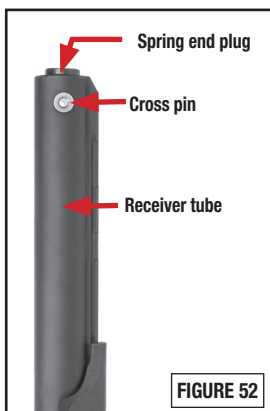
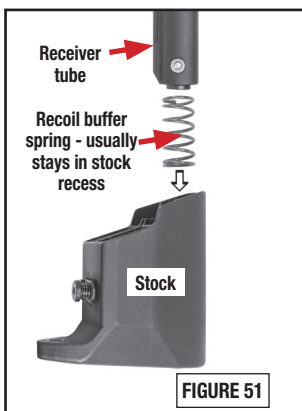

**NOTE:** The buffer spring in the stock doesn't usually fall out on its own. It can be reinstalled in either direction into the stock if it does come out.

## DISASSEMBLY/FIELD STRIPPING - CONTINUED

- Once the stock has been removed, you can see the recoil spring end plug and the cross pin (FIGURE 52).
- Next, press down firmly (about 1/8") on the spring end plug and hold it there, while you push the cross pin out of the tube (FIGURE 53).

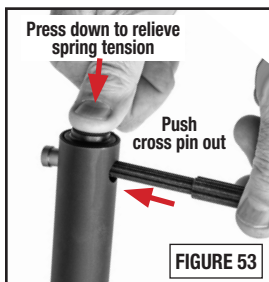

**NOTE:** The cross pin can be pushed out in either direction.

- Once the cross pin is out - the recoil spring exerts significant pressure upward. Control the spring as it pushes upward (FIGURE 54).
- Remove the recoil spring from the tube. (FIGURE 55) shows the recoil spring, end plug, and cross pin removed from the firearm.
- Next, grasp the charging slide and draw it fully rearward until it stops and the bolt carrier is showing (FIGURE 56).

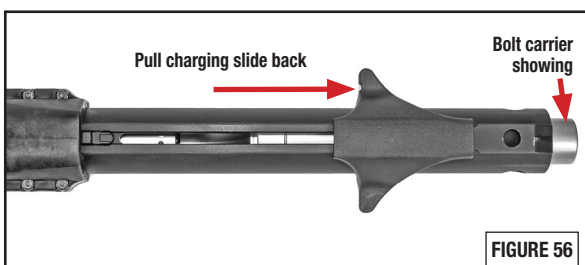
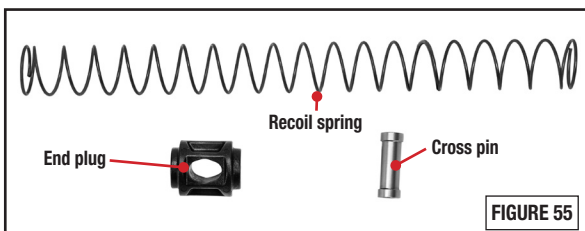
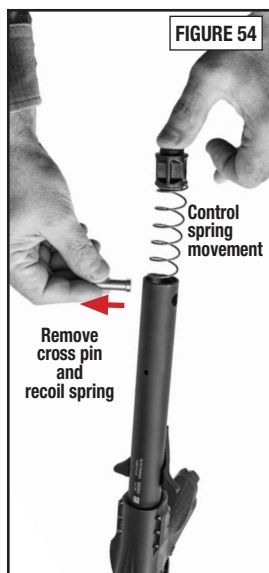

## DISASSEMBLY/FIELD STRIPPING - CONTINUED

- Push the charging slide fully forward to reveal the charging slide lug pin (FIGURE 57).

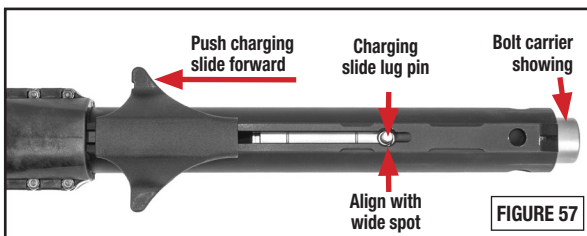

- The charging slide lug pin can usually be lifted out with a fingernail. It is helpful to grasp the bolt carrier that sticks out of the rear of the receiver tube and move it slightly to better align the pin with the wide spot in the receiver tube (FIGURE 58).

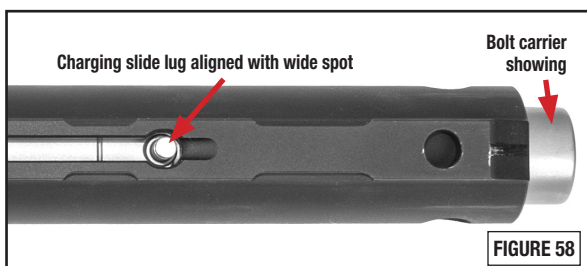

- If the charging slide lug pin doesn't come out readily, a small drift or the lanyard tool (inserted through the hole in the top of the tube) can be used to push it out (FIGURE 59).



- Pull the bolt carrier and bolt out of the tube (FIGURE 60).



## DISASSEMBLY/FIELD STRIPPING - CONTINUED

**NOTE:** Take care to control the movement of the bolt, as it will become disengaged from the bolt carrier as it clears the end of the receiver tube (FIGURES 61 and 62).

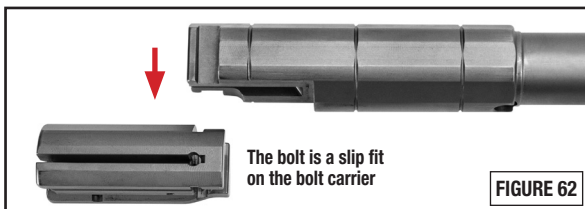
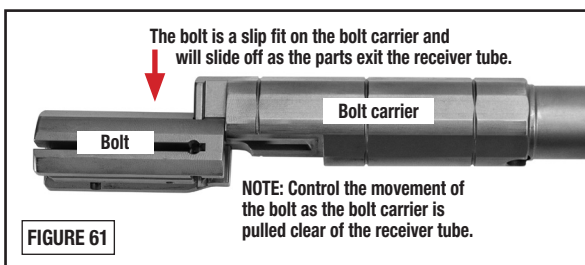

- Next, draw the charging slide rearward (FIGURE 63).

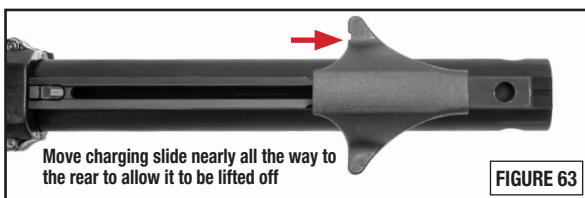

- Move the charging slide about 1/16" forward (from rear-most position) and lift it up and off the receiver tube (FIGURE 64).



- The M&P® FPC™ is now field-stripped for cleaning.

**NOTE:** Never dry-fire the M&P® FPC™ when it is disassembled. Damage to the internal parts may result.



## DISASSEMBLY/FIELD STRIPPING - CONTINUED



**WARNING: NEVER DISASSEMBLE YOUR FIREARM BEYOND THE FIELD STRIPPING PROCESS OUTLINED IN THIS MANUAL. NEVER MANIPULATE ANY INTERNAL COMPONENTS BEYOND WHAT YOU ARE SPECIFICALLY INSTRUCTED TO DO IN THIS MANUAL SINCE THIS MAY AFFECT THE RELIABILITY, FUNCTIONING AND SAFETY OF YOUR FIREARM.**



**WARNING: DO NOT ALTER, MODIFY OR REPLACE ANY OF THE PARTS OF YOUR FIREARM UNLESS THIS WORK IS PERFORMED BY A QUALIFIED GUNSMITH USING GENUINE SMITH & WESSON® PARTS. IF YOU DO OTHERWISE, IMPROPER FUNCTIONING MAY OCCUR AND INJURY MAY RESULT.**

## ASSEMBLY



**WARNING: ALWAYS FOLLOW THE FIELD/STRIPPING AND ASSEMBLY INSTRUCTIONS CLOSELY. NEVER DO ANYTHING BEYOND WHAT YOU ARE SPECIFICALLY INSTRUCTED TO DO IN THIS MANUAL. NEVER ALTER OR MODIFY THE PARTS IN YOUR FIREARM.**



**WARNING: WEAR SAFETY GLASSES EVERY TIME YOU ASSEMBLE OR DISASSEMBLE YOUR FIREARM.**

- Assemble your M&P® FPC™ in the reverse order that you took it apart.
- Lightly lubricate all metal parts by wiping them with a cloth dampened with a quality firearm oil. Remove excess oil. Leave a light film of oil on all metal parts of your M&P® FPC™ - inside and out.
- Install the charging slide onto the “tracks” at the rear of the receiver tube and then push the charging slide fully forward until it “clips” onto the retainer (FIGURES 66 and 67).

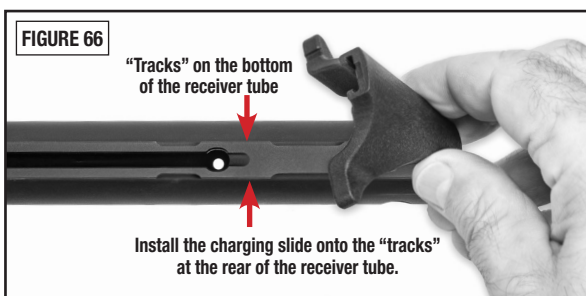



## ASSEMBLY - CONTINUED

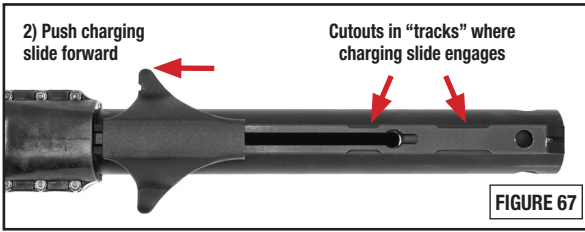

- Engage the bolt onto the rails of the bolt carrier (FIGURE 68) before sliding the parts into the receiver tube (FIGURE 69).

Engage the bolt on the bolt carrier rails before the parts are inserted into the receiver tube.

Engage bolt on rails before inserting into receiver tube.

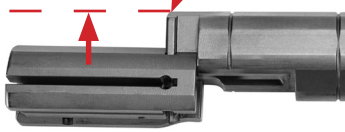

- Slide the bolt/bolt carrier into the receiver tube (FIGURE 69).



- Align the hole in the bolt carrier with the wide spot in the receiver tube (FIGURE 70) and drop/push the charging slide lug pin (FIGURE 71) into position.

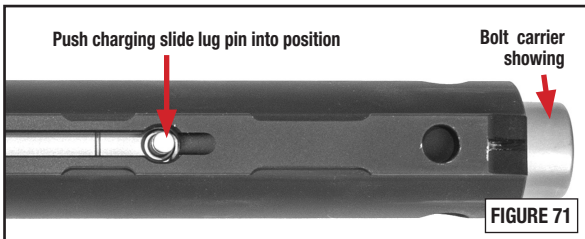
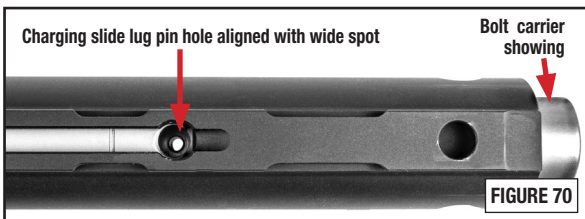

## ASSEMBLY - CONTINUED

**NOTE:** The charging slide lug pin goes into the hole in the bolt carrier with the thick part inserted first (FIGURE 72).

- Push the bolt/bolt carrier (FIGURES 73a and 73b) forward in the receiver tube.

**NOTE:** Some resistance will be encountered when the bolt rides over the internal hammer surface.

To overcome this resistance, either use the bolt carrier's own inertia by giving the gun a firm forward shake or use a sturdy wooden dowel (FIGURE 73b) or other non-marring tool to firmly push the bolt/bolt carrier until it is in the fully forward position.

- Push the bolt/bolt carrier fully forward until the bolt is closed (FIGURE 74).
- Slide the recoil spring into the receiver tube.

**NOTE:** Either end of the recoil spring can be installed into the receiver tube first.

**FIGURE 72**

Thick part goes into bolt carrier first



Charging slide lug pin

**FIGURE 73a**

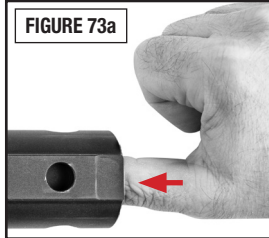

Wooden dowel

Press firmly

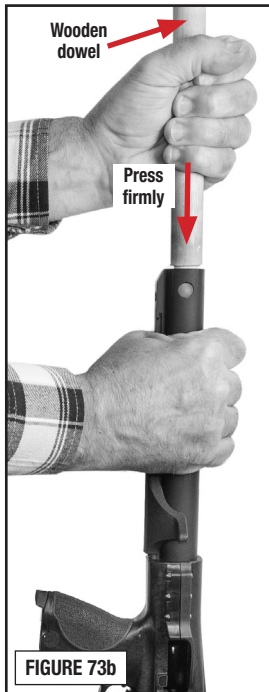

**FIGURE 73b**

Bolt in closed position

**FIGURE 74**

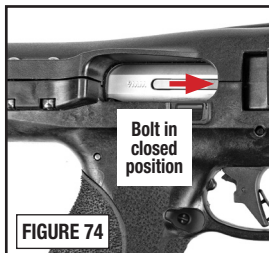

## ASSMBLY - CONTINUED

- Place the end plug on top of the spring and compress the spring into the tube (FIGURE 75).
- Once the recoil spring is compressed and the end plug is in the receiver tube, insert the cross pin through the holes in the receiver tube and the end plug (FIGURE 75).

**NOTE:** The wide, center area of the end plug will accept passage of the cross pin when it is aligned correctly (FIGURE 76).

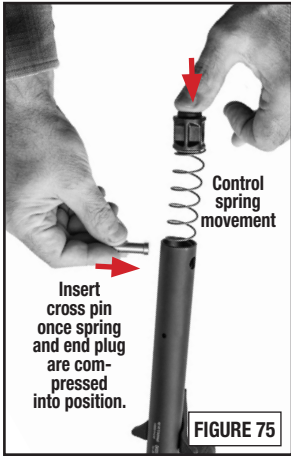

- Center the cross pin in the receiver tube (FIGURE 77) and relieve pressure on the end plug.

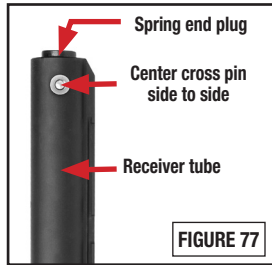
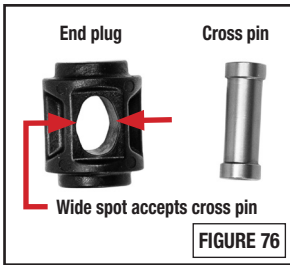

- Verify that the buffer spring is in the stock (FIGURE 78) (either end first is okay) and slide the stock onto the receiver tube.
- Compress the stock firmly against the spring pressure until the stock latch “clicks” into place on the receiver tube (FIGURE 79).

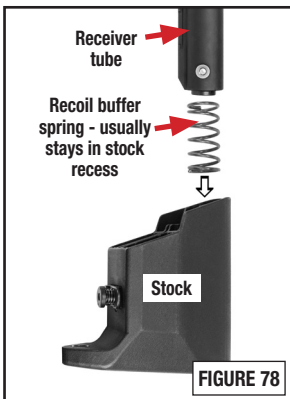

# MAGAZINES



**WARNING: WEAR SAFETY GLASSES EVERY TIME YOU DISASSEMBLE OR ASSEMBLE YOUR MAGAZINE.**



**WARNING: THE MAGAZINE SPRING IS UNDER PRESSURE. CONTROL THE SPRING AND FOLLOWER SO THAT THEY DO NOT FLY OUT AND CAUSE INJURY.**

## STANDARD MAGAZINE DISASSEMBLY

- Use a small tool (like a punch or drift) to depress floor plate catch through the hole in the floor plate (FIGURE 80).
- While holding floor plate catch down against spring pressure (FIGURE 81), slowly slide the floor plate forward off of the tube, being careful to control the spring movement.
- Remove the floor plate catch, the spring and the attached follower out through bottom of the magazine tube.
- (FIGURE 82) shows the parts of the standard magazine disassembled.

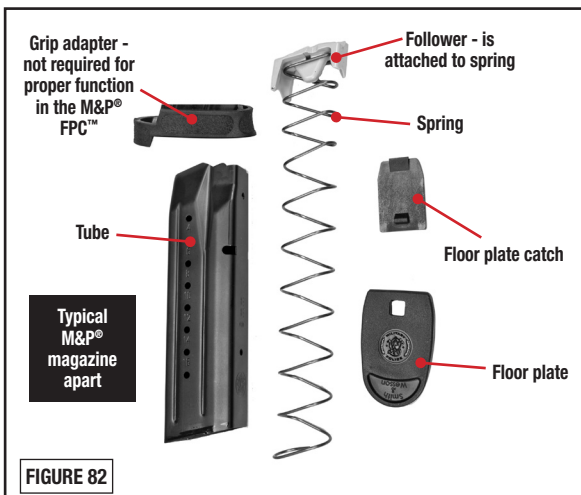
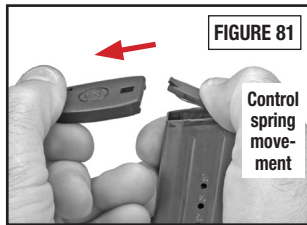

## MAGAZINES - CONTINUED

### STANDARD MAGAZINE ASSEMBLY

- Install magazine spring (with follower attached) and floor plate catch back into the tube in the same orientation as they were in when they were first removed during disassembly.
- Holding floor plate catch in the tube against spring pressure, slide the floor plate onto the tube's base so that the projection of the floor plate catch engages the floor plate. Verify that the floor plate is locked in place by exerting some pressure on the floor plate - as if trying to slide it off the tube.

### EXTENDED MAGAZINE DETAILS

- The instructions are basically the same for the extended magazine (as those for the standard magazine).
- The floor plate, floor plate catch, spring and follower are shown here in the correct orientation for assembly (FIGURE 83a).
- Install the follower, spring and floor plate catch into the tube in the same orientation as they were when removed during disassembly.

**NOTE:** The top of the spring is narrower and slanted in the extended magazine. (FIGURES 83a and 83b) show the correct orientation of the spring when assembling the extended magazine.

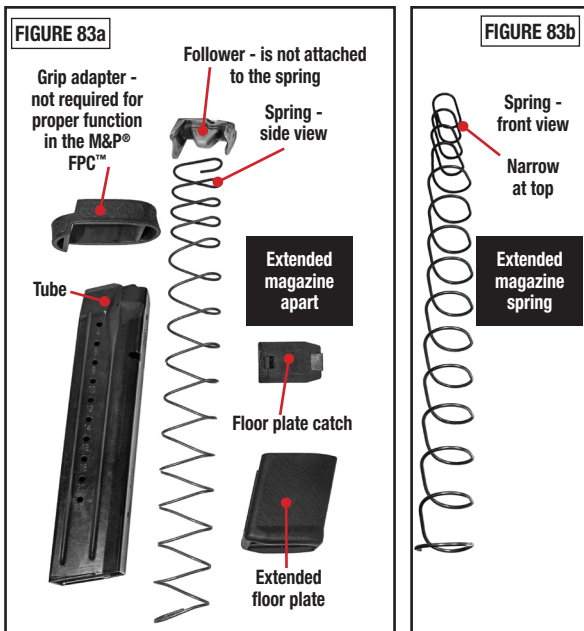

# INTERCHANGEABLE PALMSWELL GRIP INSERTS



**WARNING: ALWAYS KEEP THE MUZZLE OF THE FIREARM POINTED IN A SAFE DIRECTION.**



**WARNING: MAKE SURE THE M&P® FPC™ IS UNLOADED BEFORE CHANGING THE INTERCHANGEABLE PALMSWELL GRIP INSERTS.**

- If the interchangeable palmswell grip insert currently on your M&P® FPC™ does not fit your hand comfortably, you can install one of the four (4) different sizes that come with each M&P® FPC™ (Small, Medium, Medium-Large and Large).
- Press the magazine catch and remove the magazine (FIGURE 84) from the firearm to gain access to the lanyard tool (FIGURE 85).
- Remove the lanyard tool from the bottom of the grip by rotating it ¼ turn (either direction) and pulling it down and out of the frame (FIGURES 86 and 87).

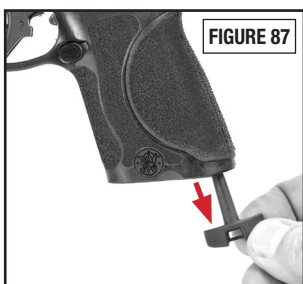
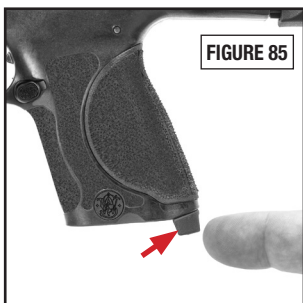

## INTERCHANGEABLE PALMSWELL GRIP INSERTS - CONT'D

- Take the current interchangeable palmswell grip insert off the M&P® FPC™ (FIGURE 89).
- Replace the interchangeable palmswell insert with the one you prefer, insert the tab at the top into the slot in the grip frame (FIGURE 90) before tipping the insert against the grip frame.
- One the interchangeable palmswell insert is in position, replace the lanyard tool into the grip.
- Replace the magazine into the M&P® FPC™.

**CAUTION:** Some solvents may cause damage to the interchangeable palmswell insert material. See the “Cleaning and Maintenance” Section of this manual for more information.

**NOTE:** The M&P® FPC™ comes with four interchangeable palmswell grip inserts: Small (S), Medium (M), Medium-Large (ML), and Large (L) sizes. The size of each is marked on the interchangeable palmswell grip inserts (FIGURE 91).

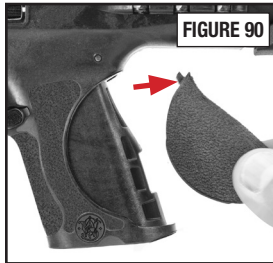
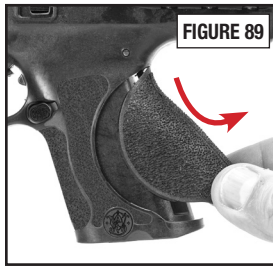

## REVERSIBLE MAGAZINE CATCH

**NOTE:** The magazine catch can be installed to operate from the right or left side. To reverse the magazine catch, follow these instructions:



**WARNING: ALWAYS KEEP THE MUZZLE OF THE FIREARM POINTED IN A SAFE DIRECTION.**



**WARNING: ENSURE THAT YOUR FIREARM IS UNLOADED BEFORE BEGINNING TO DISASSEMBLE IT.**



**WARNING: WEAR SAFETY GLASSES EVERY TIME YOU DISASSEMBLE OR ASSEMBLE YOUR FIREARM AND ATTEMPT CLEANING, MAINTENANCE OR ADJUSTMENT.**

- (FIGURE 92) shows the magazine catch plunger's location while in the M&P® FPC™.
- (FIGURE 93) shows the magazine catch removed from the M&P® FPC™ for clarity.
- Press the magazine catch and remove the magazine from the M&P® FPC™.
- When installing the magazine catch, the textured side (FIGURE 94) should be on the side of the M&P® FPC™ that you want to push on to release the magazine from the M&P® FPC™.
- A small screwdriver is used to depress the locking screw (a small amount of force is all that is required) and turn it (FIGURE 95).

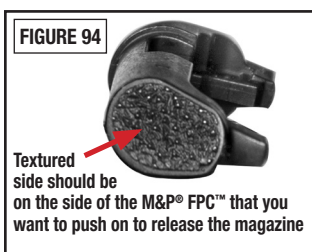
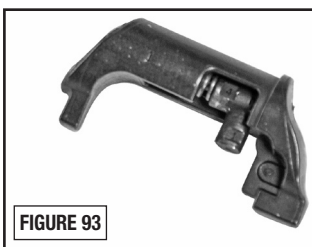
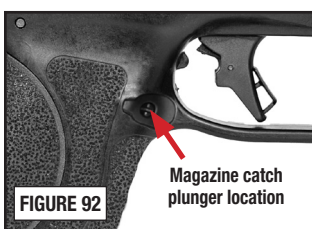

**NOTE:** When switching sides of operation of the magazine catch, the textured side must be inserted into the frame opening first.





## REVERSIBLE MAGAZINE CATCH - CONTINUED

**NOTE:** The magazine catch plunger only needs to be pushed in slightly (using a small screwdriver) in order to turn it - for either unlocking it - or locking it back into the frame. Follow the guidelines in (FIGURE 96) to remove and install the magazine catch. One-quarter turn is all that is required, in either direction, to unlock and lock.

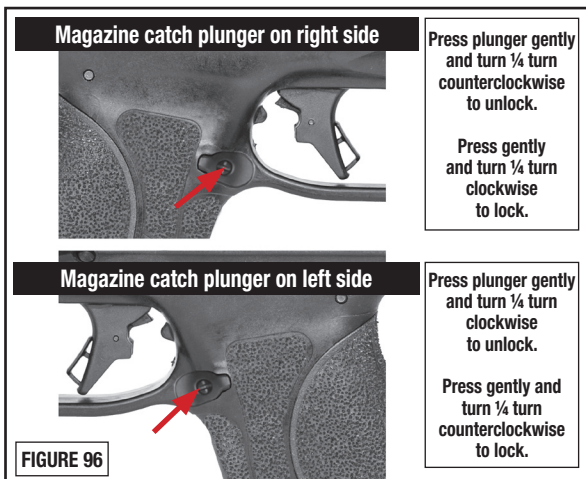

- Once the magazine catch is installed, insert an unloaded magazine into the M&P® FPC™ and check the magazine catch for proper function.

**NOTE:** If the magazine catch plunger is pressed too hard or turned too far, it may become disassembled. Reassemble the parts (FIGURE 97) before inserting the magazine catch back into the M&P® FPC™. A pair of needle nose pliers may help in the assembly process.

**WARNING: THE MAGAZINE CATCH PLUNGER SPRING IS UNDER PRESSURE IN THE ASSEMBLED MAGAZINE CATCH. WHEN DISASSEMBLING OR ASSEMBLING, CONTROL THE SPRING SO IT DOESN'T FLY OUT AND CAUSE INJURY.**

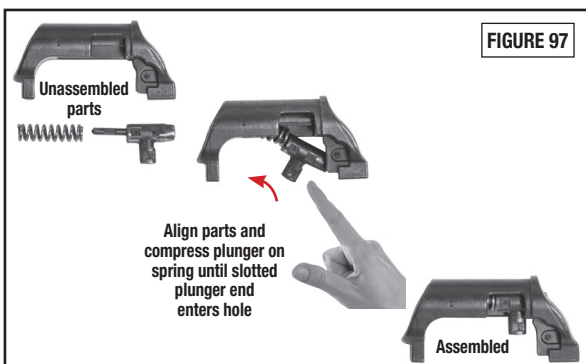

# M&P® FPC™ IN-STOCK MAGAZINE STORAGE



**WARNING: ALWAYS KEEP THE MUZZLE OF YOUR FIREARM POINTED IN A SAFE DIRECTION.**

- The stock of the M&P® FPC™ has the capacity to hold two (2) magazines (FIGURE 98).
- To latch a magazine into the stock, simply insert the magazine into the cavity until it “clicks” into position.
- The stock has a lever with two tabs (FIGURE 99).
- The user can depress a tab to release the magazine from the opposite side (FIGURES 100 and 101).
- The “plunger” in the center of the magazine tabs is used to remove the stock from the M&P® FPC™ (FIGURE 102). See the Disassembly Section of this manual for details.

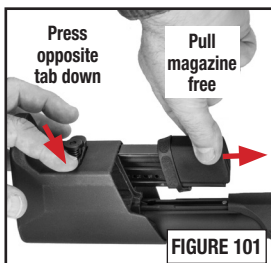
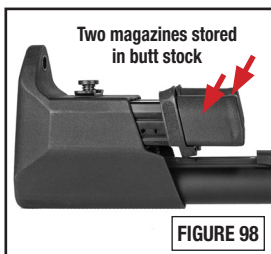

## FOLDING THE M&P® FPC™



**WARNING: ALWAYS KEEP THE MUZZLE OF YOUR FIREARM POINTED IN A SAFE DIRECTION AND ENSURE THAT YOUR M&P® FPC™ IS UNLOADED BEFORE BEGINNING TO FOLD IT.**



**WARNING: BE CAREFUL WHEN FOLDING OR UNFOLDING THE M&P® FPC™ TO AVOID PINCH POINTS.**

- To fold the M&P® FPC™ for cleaning, transport or storage, first unload the firearm and close the bolt.



- The latch that locks the M&P® FPC™ open is located on the right side (as viewed from the rear) (FIGURE 103).

- Press the latch forward in a rocking motion, while drawing the barrel to the left in a controlled manner. Release pressure on the latch once the barrel is tipped to the left (FIGURE 104).



- Continue to fold the barrel to the left in a sweeping motion. By firmly engaging the handguard against the charging slide the two parts will lock together. The user can also pull the charging slide back slightly while drawing the handguard into position against the receiver and then releasing the charging slide to engage the lock.



- (FIGURE 106) shows the notch in the charging slide that the handguard locks into.

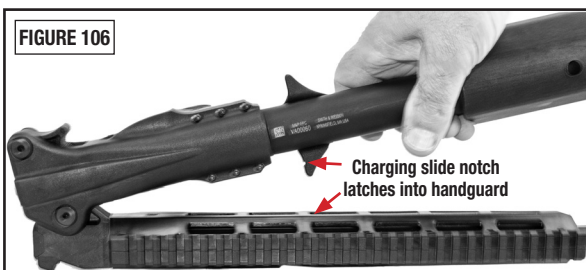

## INSTALLATION OF OPTICS



**WARNING: ALWAYS ENSURE THAT THE FIREARM IS UNLOADED BEFORE INSTALLING A SCOPE, OPTICAL SIGHT OR ANY OTHER ACCESSORIES. FAILURE TO DO THIS CAN RESULT IN INJURY OR DEATH TO YOU OR OTHERS AND DAMAGE TO PROPERTY.**

- We recommend that you have a competent gunsmith install your scope and mount.
- Scopes and optical sights have varying lengths of recommended eye relief. You need to choose a combination that allows for adequate clearance between the scope and your eye brow. Follow the instructions supplied with the scope and rings for proper installation.



**WARNING: A SCOPE OR OPTICAL SIGHT WHICH IS NOT SECURELY MOUNTED MAY BECOME DETACHED UPON RECOIL OF THE FIREARM. IF IT BECOMES DETACHED IT MAY FLY BACK AND STRIKE THE SHOOTER OR A BYSTANDER AND CAUSE INJURY. OBSERVE THE CONDITION OF ALL THE SCOPE MOUNT SCREWS AFTER FIRING. IF THE MOUNTING SCREWS SHOW SIGNS OF LOOSENING DO NOT FIRE THE GUN AGAIN; CALL THE CUSTOMER SERVICE DEPT. FOR ASSISTANCE AT 1-800-331-0852 EXT 4125.**



**WARNING: FIRING A FIREARM WITH YOUR EYE TOO CLOSE TO THE EYE PIECE OF A SCOPE OR OPTICAL SIGHT, OR FAILING TO HOLD THE FIREARM SECURELY AGAINST RECOIL, MAY RESULT IN PERSONAL INJURY INCLUDING, BUT NOT LIMITED TO, BLINDNESS. MAINTAIN ADEQUATE CLEARANCE BETWEEN ANY SIGHTING DEVICE THAT IS INSTALLED AND OPERATOR'S EYE (FIGURE 107).**



---

## CLEANING AND MAINTENANCE

---



**WARNING: ENSURE THAT YOUR FIREARM IS UNLOADED BEFORE BEGINNING TO CLEAN IT. (SEE “INSPECTING YOUR FIREARM” SECTION). ALWAYS FOLLOW THE RULES OF SAFE FIREARM HANDLING.**



**WARNING: WEAR SAFETY GLASSES EVERY TIME YOU ASSEMBLE OR DISASSEMBLE YOUR FIREARM AND ATTEMPT CLEANING OR MAINTENANCE.**

- Before using your firearm for the first time, it should be cleaned.
- Your firearm was treated at the factory with either a preservative or oil to protect it against corrosion during shipping and storage.
- Preservative and oil should be wiped from the bore, chamber and exposed areas using a clean swab or patch before using the firearm.

**CAUTION:** Never disassemble your firearm beyond the instructions in the Field Stripping and Inspection Sections of this manual.

- Purchase cleaning supplies from your firearms dealer that are specifically designated for your type and caliber of firearm. Many suppliers offer these in kit form for your convenience.
- Follow the instructions provided with your cleaning supplies.

**NOTE:** A basic firearm cleaning kit should include: a brass bore brush and a cleaning jag of appropriate size for the bore being cleaned, high-quality gun cleaning solvent and gun oil/lubricant, cotton cleaning patches and a cleaning rod that is long enough to push the brush and jag completely through the barrel.

- Remove excessive firing residue from the bore and chamber using a properly fitted brass brush dipped in gun cleaning solvent. Finish the bore cleaning process by running a dry cotton cloth patch through the bore and chamber to remove residue and solvent.
- Clean the exterior of the firearm using a non-abrasive cleaning cloth.
- After cleaning, lightly coat the metal parts, internal and external with a high quality firearm oil.
- Whenever your firearm has been exposed to sand, dust, extreme humidity, water or other adverse conditions, it must be cleaned and lubricated.

---

## CLEANING AND MAINTENANCE - CONTINUED

---



**WARNING: ALWAYS HAVE ADEQUATE VENTILATION. CLEANING FIREARMS IN POORLY VENTILATED AREAS, DISCHARGING FIREARMS, OR HANDLING AMMUNITION MAY RESULT IN EXPOSURE TO LEAD AND OTHER SUBSTANCES KNOWN TO CAUSE BIRTH DEFECTS, REPRODUCTIVE HARM AND OTHER PHYSICAL INJURY. WASH HANDS THOROUGHLY AFTER EXPOSURE.**

**CAUTION:** Always follow the instructions provided with your firearm cleaner and firearm lubricant.

**CAUTION:** Some cleaners can cause damage to your firearm. You should avoid prolonged solvent immersion and prolonged ultrasonic cleaning of your firearm. Choice of solvent should be restricted to those products specifically developed for firearms maintenance. Damage to a firearm's finish may occur if these cautions are ignored. Ammoniated solvents or other strong alkaline solvents should not be used on any Smith & Wesson® firearm. Cleaning is essential to ensure the proper functioning of your firearm.

- Your firearm is a precision instrument. To ensure reliable function it is necessary to follow a routine maintenance procedure. After firing your firearm, be sure to unload it following the procedure outlined in the "Inspecting Your Firearm" Section of this manual before performing any cleaning or maintenance procedure.
- Remove any firearm cleaning solution, oil and fingerprints from the outside surfaces of the firearm. Finger moisture, if left, could start a corrosion process.

**CAUTION:** Some solvents may cause damage to the interchangeable palmwell insert material. Choice of solvent should be restricted to those products specifically developed for firearms maintenance.



**WARNING: NEVER MANIPULATE, ADJUST OR CHANGE ANY OF THE INTERNAL COMPONENTS OF YOUR FIREARM UNLESS SPECIFICALLY DIRECTED TO DO SO IN THIS MANUAL. IMPROPER MANIPULATION OF ANY INTERNAL COMPONENT MAY AFFECT THE SAFETY AND RELIABILITY OF YOUR FIREARM AND MAY CAUSE INJURY OR DEATH.**



**WARNING: ANY MAINTENANCE, ADJUSTMENT OR SERVICE NOT SPECIFIED IN THIS MANUAL MAY AFFECT THE SAFETY AND RELIABILITY OF YOUR FIREARM AND MUST BE PERFORMED BY A QUALIFIED GUNSMITH USING GENUINE SMITH & WESSON® PARTS. IF YOU DO OTHERWISE, IMPROPER FUNCTIONING OF YOUR FIREARM MAY OCCUR AND INJURY OR DEATH AND DAMAGE TO PROPERTY MAY RESULT.**

---

## CLEANING AND MAINTENANCE - CONTINUED

---

- If your firearm will be used in a cold climate, be sure to use an oil of an appropriate weight so that it will not congeal in cold temperatures, causing the interaction of important parts to be slowed or halted.

### MAINTENANCE BEFORE STORAGE

- When storing, do not encase your firearm in anything that will attract or hold moisture, for example, leather or heavy cloth. Also, do not store firearms with a plug inserted in the barrel for this can be a contributing factor to moisture accumulation. If your firearm is to be stored for an extended period, the bore, chamber and internal surfaces should be oiled with a high quality lubricating oil or preservative intended for firearms.
- The external parts, receiver, bolt and barrel should be coated with an anti-rust oil. Before using your firearm again, be sure to clean it. Every time you clean your firearm, check it for signs of wear. If wear is noted, do not use the firearm. Return it to Smith & Wesson® for service or have it checked by a qualified gunsmith.

---

## LIMITED WARRANTY

### For Owners Within The United States

---

This warranty is granted by Smith & Wesson® Brands Inc. This warranty is effective from the date of purchase and applies to the original owner of any firearm. With respect to such firearms, this warranty supersedes any and all other warranties.

Smith & Wesson® firearms are warranted to be free from defects in material and workmanship. Any such defects of which Smith & Wesson® receives written notice within one year from the date of purchase by the original owner, will be remedied by Smith & Wesson® without charge within a reasonable time after such notification and delivery of the firearm as provided below.

In the event of an emergency (repairs needed by law enforcement, an upcoming match or hunting trip), call 1-800-331-0852, ext. 4125 and ask for 911 Priority Repair Service. This allows you to speak with a Smith & Wesson® representative. Immediately upon receipt, your firearm will be assigned to a gunsmith. After the work is completed, we will return your Smith & Wesson® firearm via overnight delivery.

---

## LIMITED WARRANTY - CONTINUED

---

Warranty claims (in writing) and the firearm concerned should be delivered to Smith & Wesson's Customer Service Department, 2100 Roosevelt Avenue, Springfield, Massachusetts 01104. In addition, a copy of the bill of sale in the owner's name, or a copy of ATF Form 4473 indicating date of purchase must be included. It is important that the owner comply with all applicable federal, state and local laws and regulations in the shipment of firearms to Smith & Wesson®.

**NOTE:** See the Contact and Shipping Section of this manual for further details regarding returns.

Warranty claims should state the model and serial number of the firearm concerned and the description of the difficulty experienced. It is recommended that shipments be insured by the owner, since Smith & Wesson® will accept no responsibility for loss or damage in transit. Transportation and insurance charges for return to owner will be paid by Smith & Wesson® if the claim is covered by the warranty.

**UNDER NO CIRCUMSTANCES SHALL SMITH & WESSON® BE RESPONSIBLE FOR INCIDENTAL OR CONSEQUENTIAL DAMAGES WITH RESPECT TO ECONOMIC LOSS, INJURY, DEATH OR PROPERTY DAMAGE, WHETHER AS A RESULT OF BREACH OF THIS WARRANTY, NEGLIGENCE OR OTHERWISE.**

Some states do not allow the exclusion or limitation of incidental or consequential damages, so the above limitation or exclusion may not apply to you.

**Smith & Wesson® will not be responsible for:**

- Defects or malfunctions resulting from careless handling, unauthorized adjustments or modifications made or attempted by anyone other than a qualified gunsmith following Smith & Wesson® authorized procedures, or failure to follow the disassembly instructions in the Smith & Wesson® Safety and Instruction Manual.
- Use of defective or improper ammunition, corrosion, neglect, abuse, ordinary wear and tear, or unreasonable use.
- Criminal misuse, negligence or use under the influence of drugs or alcohol.



---

## LIMITED WARRANTY - CONTINUED

---

Smith & Wesson's Lifetime Service Policy begins after the warranty period has expired. Smith & Wesson® will repair, without charge, for the lifetime of the original owner, any Smith & Wesson® M&P® FPC™, and any M&P® series carbine, that is found to have a defect in material or workmanship. Eligibility for this Lifetime Service Policy requires returning the Product Registration Card within 30 days of purchase. The Lifetime Service Policy covers functional defects; it does not include the firearm's finish, grips, magazines or sights. The Lifetime Service Policy is in addition to and not an extension of the Smith & Wesson® Warranty. This warranty gives you specific legal rights. You may also have other rights that vary from state to state.

**NOTE:** All liability is excluded in the event that the instructions in the Smith & Wesson® Safety and Instruction Manual are not observed.

---

## CONTACT & SHIPPING INFORMATION

### For Owners Within The United States

---

**NOTE:** A Return Merchandise Authorization (**RMA**) is the first step in the process of returning a product in order to receive a repair, replacement or refund. Please contact Smith & Wesson's Customer Service Dept. (via e-mail: [qa@smith-wesson.com](mailto:qa@smith-wesson.com) or by phone at 1-800-331-0852 ext. 4125) to obtain authorization to return your firearm so we can process it quickly and efficiently. The RMA number that is supplied by Smith & Wesson must be displayed on the outside of the returned product's packaging; returns without an RMA number will be routed differently which will result in delayed processing.

The issuance of an Return Merchandise Authorization (**RMA**) allows Smith & Wesson® an opportunity to try to diagnose and correct a customer's concerns with the product (such as ammunition problems) before it is returned. Accordingly, please contact us before returning your Smith & Wesson® firearm.

#### CONTACT CUSTOMER SERVICE

Tel: 1-800-331-0852 • 1-413-781-8300 ext. 4125

E-mail: [qa@smith-wesson.com](mailto:qa@smith-wesson.com)

RETURNS - FOR SERVICE

#### ALL SMITH & WESSON FIREARMS

Smith & Wesson  
2100 Roosevelt Avenue  
Springfield, MA 01104

---

## CONTACT AND SHIPPING - CONTINUED

---

Should your Smith & Wesson® firearm require service, it should be returned to the Smith & Wesson® factory.

- Call or e-mail the Customer Service Department for authorization and shipping instructions.
- Ensure that the firearm is unloaded.
- **Do not attempt to ship a firearm via US Postal Service; only federally licensed dealers may ship a firearm by US Postal Service.**
- **DO NOT SHIP ANY AMMUNITION.**
- Enclose a letter which includes your full name and address (no P.O. Boxes, please), daytime telephone number, e-mail address, the serial number of the firearm, and details of the problem experienced (stating the brand and type of ammunition used when the problem occurred) or work desired.
- Record the serial number before shipping, in case you wish to check on the repair status of your firearm.
- Please remove all custom parts and accessories, such as stocks, special sights and scopes, or slings from your firearm before returning.
- Place the firearm in its original case or in a similarly secure container and pack it securely.
- The package must NOT bear any markings which indicate the identity of the contents.
- It is most important that you comply with federal, state, and local laws and regulations. The following guidelines are meant to help, but you must seek assistance from the appropriate authorities if necessary.
- If your firearm must be replaced, it may be necessary to ship the replacement to a dealer rather than directly to you. You will be requested to furnish a signed FFL (Federal Firearms License) from your dealer in such an instance.
- Warranty repair work will begin upon receipt and examination of the firearm. In the case of repairs or work not covered by the warranty, a quotation covering the cost of the work plus round trip transportation charges will be sent to you. Repairs or modification will be scheduled upon receipt of payment.

---

## CONTACT AND SHIPPING - CONTINUED

---

- A parts list can be obtained by contacting Smith & Wesson®.



**WARNING: YOU MAY PURCHASE ACCESSORIES FOR YOUR SMITH & WESSON® FIREARM. YOU MUST HAVE SOME OF THESE PARTS INSTALLED BY A GUNSMITH QUALIFIED TO PERFORM SERVICE ON SMITH & WESSON® FIREARMS. YOU MUST NEVER ATTEMPT TO MODIFY YOUR FIREARM OR INSTALL REPLACEMENT PARTS IN YOUR FIREARM. ALWAYS USE A QUALIFIED SMITH & WESSON® GUNSMITH EVEN IF THE REPAIR SEEMS SIMPLE.**

---

## CUSTOM SERVICE

---

We understand that Smith & Wesson® gun owners may want to enhance their guns with custom gunsmithing, refinishing or accessories. Our gunsmiths offer specialized services and exclusive products to enhance your shooting experience.

Accessories for your Smith & Wesson® firearm are available from your local Smith & Wesson® Authorized Dealer, or directly from Smith & Wesson®.

Contact the Customer Service Department at 1-800-331-0852, extension 4125 for information about these services.

When ordering directly from the factory, please provide the following information:

- Model Number
- Dash Number
- Serial Number
- Approximate date of purchase
- Complete Return Address
- VISA/Discover/MasterCard Number & Expiration Date
- For Foreign Orders Only, Fax Number or E-mail Address

---

## PATENT INFORMATION

---

- This product may be covered by one or more patents. Visit <https://www.smith-wesson.com/company/virtual-patent-marking> for virtual patent information.

---

## BATTERY WARNINGS

---



**WARNING: IF A BATTERY OPERATED ACCESSORY OR ATTACHMENT (I.E., LASER, OPTICAL SIGHT OR FLASHLIGHT, ETC.) IS SUPPLIED OR USED WITH THIS FIREARM, THE FOLLOWING WARNINGS AND INSTRUCTIONS MUST BE ADHERED TO.**



**WARNING: KEEP BATTERIES AWAY FROM CHILDREN. THERE IS A CHEMICAL BURN HAZARD ASSOCIATED WITH BATTERIES.**



**WARNING: IF A NEW OR USED LITHIUM BUTTON/COIN CELL BATTERY IS SWALLOWED OR ENTERS THE BODY, IT CAN CAUSE SEVERE INTERNAL BURNS AND CAN LEAD TO DEATH IN AS LITTLE AS 2 HOURS. ALWAYS COMPLETELY SECURE THE BATTERY COMPARTMENT. IF THE BATTERY COMPARTMENT DOES NOT CLOSE SECURELY, STOP USING THE PRODUCT, REMOVE THE BATTERIES, AND KEEP IT AWAY FROM CHILDREN. IF YOU THINK BATTERIES MIGHT HAVE BEEN SWALLOWED OR PLACED INSIDE ANY PART OF THE BODY, SEEK IMMEDIATE MEDICAL ATTENTION.**

- When used correctly, batteries provide a safe and dependable source of portable power. However, misuse or abuse may result in leakage, fire, or explosion.
- Batteries can explode or leak and cause burns if installed backwards, disassembled, charged, or exposed to water, fire or high temperature.
- Always take care to install your batteries correctly observing the “+” and “-” marks on the battery and the device.
- Always replace the whole set of batteries at one time, taking care not to mix old and new batteries, or batteries of different types.
- Store unused batteries in their original packaging and away from metal objects that may short-circuit them.
- Remove discharged batteries from equipment promptly to avoid possible damage from leakage.
- Never dispose of batteries in fire. Failure to observe this precaution may result in an explosion.
- The batteries are supplied in a charged state and are not designed for recharging. Recharging may cause leakage, fire, or explosion.
- The batteries should be disposed of properly, including keeping them away from children.
- Dispose of used batteries immediately. Even used batteries may cause injury.



3015694

Smith & Wesson®

2100 Roosevelt Avenue • Springfield, MA 01104

[www.smith-wesson.com](http://www.smith-wesson.com)

p/n 3015694

REV:M&P\_FPC-083023