



# TX 22

**INSTRUCTION MANUAL**

## **GENERAL SAFETY, OPERATING INSTRUCTIONS AND LIMITED WARRANTY**

### **READ CAREFULLY BEFORE USING YOUR FIREARM**

**Important: Keep this manual with your firearm.**

The information contained in this manual is useful, both for beginners and experienced shooters. In addition to important information about the function, cleaning and care of the firearm, this manual contains instructions that may be very helpful in shooting safely.

**The most important rule of safe firearm handling is always keep the muzzle pointed in a safe direction!**



# TX 22

[TaurusUSA.com](http://TaurusUSA.com)



- Available in .22LR
- 16 round and 10 round capacity
- Matte black finish
- Hard anodized slide
- Single action
- Adjustable rear sight
- Trigger safety
- Ambidextrous manual safety (Optional)

## CONTENTS

Firearm Safety.....	6
Get To Know Your Pistol.....	14
Ammunition .....	20
Operating Instructions.....	24
Disassembly .....	28
Assembly .....	31
Care and Maintenance.....	34
Exploded View.....	36
Taurus® Service .....	38
Limited Warranty .....	40

### **WARNING**

The safety warnings in this booklet are important. By understanding the dangers inherent in the use of any firearm, and by taking the precautions described herein, you can safely enjoy your Taurus® firearm. Failure to follow any of these warnings may result in serious injury to you or others, as well as severe damage to the firearm or other property.

*Intentionally left blank*

## NOTES



---

---

---

---

### SIGNAL WORDS AS DEFINED BY ANSI Z535.6 AND Z535.4 STANDARDS.

 <b>DANGER</b>	DANGER indicates a hazardous situation which, if not avoided, will result in death or serious injury.
 <b>WARNING</b>	WARNING indicates a hazardous situation which, if not avoided, could result in death or serious injury.
 <b>CAUTION</b>	CAUTION indicates a hazardous situation which, if not avoided, could result in minor or moderate injury.
<b>NOTICE</b>	NOTICE is used to address practices not related to physical injury.

## FIREARM SAFETY

### **WARNING**

When a firearm discharges, the bullet or shot can strike a person, resulting in death or serious bodily injury.

The three basic keys to safe handling of firearms:

- 1. KEEP YOUR FINGER OFF THE TRIGGER UNTIL YOU ARE READY TO FIRE.** If you maintain good trigger discipline, it is extremely unlikely the firearm will fire.
- 2. KEEP THE MUZZLE POINTED IN A SAFE DIRECTION.** Even if the firearm discharges, if the muzzle is pointed in a safe direction, no one will be injured.
- 3. NEVER TRUST ANY SAFETY MECHANISM.** If you adopt the attitude that you will not trust any safety mechanism, you will be vigilant about keeping your finger off the trigger and keeping the muzzle pointed in a safe direction.

### **WARNING - KNOW YOUR TARGET**

Never fire at targets at close range. Ricochets can and do cause death or serious bodily injury. What constitutes “close range” depends on many factors including target material, bullet caliber and angle of impact.

**KNOW WHAT IS BEHIND YOUR TARGET.** Unless you are shooting into a bullet trap designed to capture the type of ammunition you are firing, projectiles may pass through the target and strike anyone or anything beyond. Bullets can travel miles.

**ALWAYS WEAR HEARING PROTECTION.** Firearms are loud. The sound they generate is greater indoors. Repeated exposure to loud noises can cause deafness. Hearing protection is rated by decibel reduction. Look for “dB” reduction of 30 or more when purchasing ear protection. Modern ear protection can allow normal hearing until the sound from the discharge reaches the ear. Layering hearing protection, for example, wearing 30db rated foam plugs with 20db rated ear muffs, significant protection can be achieved.

**ALWAYS WEAR EYE PROTECTION.** In normal operation, firearms emit hot high-velocity gases, particles and metal. These materials flying into your eye can cause blindness. Protect your vision with proper eye protection. Any eye protection may be better than none, but look for ANSI Z87.1-2003 certified eyewear for the best protection.

**NEVER HANDLE FIREARMS WHILE UNDER THE INFLUENCE OF DRUGS OR ALCOHOL.** Firearms are dangerous. Handling firearms while impaired by drugs or alcohol is foolhardy and may result in serious injury or death. This warning includes prescription drugs that contain a warning about using machinery or driving while taking the medication.

**MODIFIED FIREARMS ARE DANGEROUS, AND USE CAN RESULT IN SERIOUS INJURY OR DEATH.** “Trigger jobs,” polishing original components or installing aftermarket parts can cause a firearm to function in ways different than intended. Some such work may also be illegal.

**DAMAGED FIREARMS ARE DANGEROUS, AND USE CAN RESULT IN SERIOUS INJURY OR DEATH.** Repairs should always be made by a qualified gunsmith or by a factory-authorized repair site. Work done by those unfamiliar with the design can cause a firearm to function in ways different than intended.

**NEVER ATTEMPT TO DISASSEMBLE OR CLEAN A LOADED FIREARM. DOING SO CAN RESULT IN SERIOUS BODILY INJURY OR DEATH.** How often have we heard “But it went off while I was cleaning it!” or, “I did not know it was loaded!” or, “It was jammed, and I tried to take it apart!”?

**IF A FIREARM GOES OFF, THERE WAS A ROUND OF AMMUNITION IN THE CHAMBER.** Period. “Clear” (or empty) the firearm of all ammunition before disassembling or cleaning.

As owner of your new Taurus® firearm, you are responsible for (1) keeping your finger off the trigger, (2) pointing the muzzle in a safe direction, (3) removing the magazine, (4) pulling the slide to the rear and locking it back and (5) looking and feeling in the magazine well and chamber to confirm the pistol is empty. An empty firearm cannot fire.

## FIREARM SAFETY SYSTEMS

Firearm safety is supported by a system. With your pistol, the system is made up of the following:

- 1. You!** Your involvement in safety cannot be overemphasized. No safety component can keep your finger off the trigger and the muzzle pointed in a safe direction. Also, you are the key to never trusting any of the mechanical parts of the safety system.
- 2. Manual Safety (on certain TX22 models).** If your firearm is equipped with, always use the manual safety. When you need it to work, it needs to be all the way in the Safe position, not half way or at some other point in its travel. Don't play with the manual safety and you will avoid accidents.

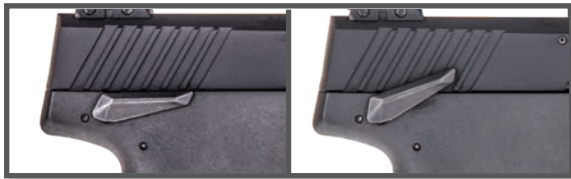

Firing Position

Safety Position

**3. Trigger Safety.** The trigger safety serves the same kind of function as the manual safety. It must be in the Fire position to fire the pistol. With a trigger safety, the safety moves to the Fire position when you press the trigger.

**4. Striker Block.** The striker block interferes with the forward travel of the striker until the trigger is pulled. Like a trigger safety, pressing the trigger moves this safety component from its “safe” (blocking) position to its “fire” (free) position.

**5. Trigger Guard.** This is a physical obstruction that helps prevent unintended pressing of the trigger or trigger safety. Do not modify the trigger guard.

**6. This Manual.** Taurus intends for you to use this manual to learn about your pistol and to help you use your pistol safely. If you use the manual, you will be a long way toward being a knowledgeable and safe firearms owner.

## PISTOL AND REVOLVER SIZE AND SAFETY

The selection of a revolver versus a pistol as well as the size, caliber and magazine capacity of a handgun are personal choices. There are many choices to be made, and there are advantages and disadvantages for each. When selecting a pistol, size has safety implications because of the way pistols are loaded.

Generally speaking, smaller handguns may require more attention to be handled safely than medium or full-size handguns. This is because their small size makes it easier to point the muzzle at your hand or to “sweep” (swing the muzzle across your body) yourself in ordinary handling.

When chambering a round, we recommend pulling the slide to the rear by gripping the rear of the slide, with the muzzle pointed straight and away from your body and in a safe direction.

## SAFE CARRY CONDITION

“Safe Carry Condition” is the most ready-to-fire condition that the user feels is reasonable under the circumstances. Generally, we believe that Taurus pistols should be carried with a full magazine and an empty chamber. Under most circumstances, this provides the best balance of readiness and safety. On the plus side, if the chamber is empty, unintended discharges are minimized. However, the slide must be manipulated to load a round in the chamber. In emergency circumstances, this can be difficult to do safely and correctly.

If the user believes that he or she is faced with an increased threat, chambering a round is appropriate. For safety reasons, this should be done beforehand with the muzzle pointed in a safe direction, your finger off the trigger. If equipped, place the manual safety in the “safe” position. How do you know you may be going into a more dangerous situation? That depends. If, for example, you carry cash to deposit after a business closing, this may well qualify. If a domestic partner is actively threatening you, this may qualify as well.

“Safe Carry Condition” is a judgment call and must be made by the user. Some users routinely face greater threats than others. Users must be aware of their situation and circumstances. Errors in judgment can have dire and tragic outcomes if firearms are present.

## CARRYING FIREARMS

Carrying a firearm can be dangerous. Carrying a firearm makes it more difficult to control the muzzle and makes it more likely that the firearm can be dropped or bumped causing the firearm to fire.

In almost all circumstances, it is safest to carry a handgun in a holster designed for that specific handgun. Carrying a handgun in a pocket without a specific designed In-Pocket Holster or a trigger shield or in a waist band without a belt clip is always a last choice. Carrying any handgun in a holster that fits the firearm and style of carry should prevent it from accidentally falling and you from losing control of the muzzle.

Except in rare high-threat circumstances, carry your pistol with a full magazine and an empty chamber. If the chamber is empty, the pistol cannot fire.



### WARNING - CARRYING

Do not carry your firearm in any way that might let it fall or be bumped. If a firearm falls or is bumped, it may fire.



### WARNING - CARRYING

Always review and follow the holster or luggage manufacturer's instructions or the firearm may fall or be bumped and fire.

## FIREARM STORAGE AND GUN LOCKS

How you secure your firearm is a personal choice based on the unique circumstances in your home, business or vehicle and the laws of the state where your firearm is located. Any choice you make about securing your firearm will present advantages and disadvantages. You must weigh those advantages and disadvantages and choose which security method is best for you and those around you.



### WARNING - LOCKING

Never lock a firearm with a round of ammunition in the chamber. Unlocking a loaded firearm makes it more difficult to maintain trigger discipline and to keep the muzzle pointed in a safe direction.



### WARNING

Securing your firearm may inhibit access in a defensive situation and may result in injury or death.



### WARNING

Failure to secure a firearm may result in injury or death. Properly securing a firearm means storing your firearm unloaded, decocked and securely locked, with all ammunition in a separate location.

## GET TO KNOW YOUR PISTOL



## SPECIFICATIONS

Model	TX22
Caliber	.22LR
Action	Single Action
Capacity	16 Rounds/10 Rounds
Barrel Length	4.1"
Overall Length	7.06"
Overall Height	5.44"
Overall Width	1.25" (at widest point)
Weight	17.3 oz.
Sights	Adjustable: 3 White Dot System
Materials	Slide: High Grade Aluminum Barrel: Alloy Steel Grip: Polymer
Safety Devices	Striker Block, Trigger Safety, Manual Safety (on certain models)
Finish	Hard Anodize Black
Remarks	Accessory Rail (Picatinny MIL-STD-1913)



## SIGHT ADJUSTMENT

### NOTICE

To adjust, make sure the firearm is unloaded and always keep the muzzle pointed in a safe direction. If possible, leave the slide open (full rearward position) during adjustment.

### ELEVATION ADJUSTMENT

The rear sight can be adjusted in elevation to raise or lower the point of impact. When raising the sight, the point of impact rises. Lowering the sight, the point of impact is lowered.

The sight adjustment does not have a stop at the end, so while adjusting the sight you must pay attention to the click according to the sight movements (up or down).

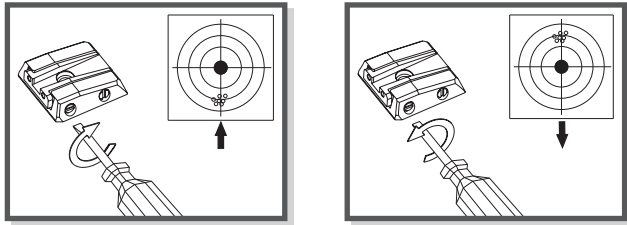

### WINDAGE ADJUSTMENT

The rear sight can also be adjusted for windage. Turn the windage adjusting screw clockwise to move the notch, and point of impact, to right side. Turn the windage adjusting screw counter-clockwise to move the notch, and point of impact, to left side.

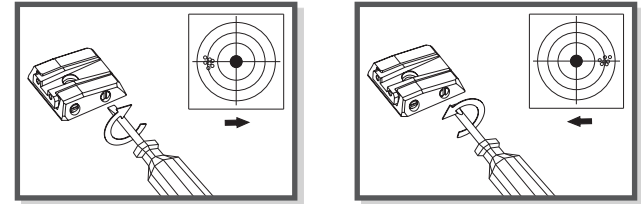

## LOCKING DEVICE INSTALLATION INSTRUCTIONS



### WARNING - LOCKING DEVICES

- Always keep your firearm pointed in a safe direction, including when you are installing or removing your locking device.
- Always verify that your firearm is completely unloaded (see page 28) before installing your locking device.
- Do not install locking devices in the trigger guard; always keep your fingers and locking device outside the trigger guard during device installation and removal.
- Store firearms, ammunition and keys separately and securely, away from children and careless adults; do not store your firearm with the keys in the locking device.
- Do not attempt to work the action of your firearm with the locking device in place; this may damage your firearm.
- While locking devices are an important aid to security measures, they are not a substitute for safe firearm handling and proper storage. Remember that any mechanical device can be bypassed with enough time, knowledge, determination and equipment.

LOCKING DEVICES MUST BE USED SAFELY AND RESPONSIBLY

### It is important to use the locking device on your Taurus firearm!

Keep the muzzle pointed in a safe direction and your fingers outside the trigger guard at all times during installation of the locking device!

#### To Install the Factory-Supplied Locking Device:

1. Remove the magazine from your pistol.
2. Open the action completely, and verify that the firearm is completely unloaded and contains no cartridges or cartridge cases! Use the slide stop to keep the action open during installation of the locking device.
3. Insert the cable directly in your pistol as shown in Figure 1.
4. To lock: With the key turned to the farthest clockwise position, insert the loose end of the cable into the lock. Turn the key counterclockwise and remove the key.
5. Once the lock is securely closed, pull firmly on the lock to test the connection and be sure it is locked. Do not leave or store your firearm with the key in the lock! Store your locked, unloaded firearm and the key in secure, separate locations, away from ammunition, children, and careless adults.



### WARNING

Never leave your keys in the lock when the lock is installed on the firearm.

## AMMUNITION

### **WARNING**

Using the wrong ammunition in your pistol can result in serious bodily injury and damage to your pistol. Make certain the ammunition you load in the magazine is the same caliber as is marked on the pistol.

### **WARNING - AMMUNITION AND INDUSTRY STANDARDS**

Use only clean, dry factory-loaded ammunition. Old, damaged, wet or oily ammunition may fire at pressures higher than industry standard, causing injury to you and bystanders or damage to your pistol.

Do not use reloaded ammunition in your pistol. Its firing pressures are unknown and may well exceed industry standard, causing injury to you and bystanders or damage to your pistol.

Odd sounds are signs of trouble. If a round "does not sound right" when it goes off, stop firing right away. A bullet may be stuck in the barrel. Firing the pistol in this condition may cause pressures higher than industry standard, causing injury to you and bystanders or damage to your pistol.

If you hear any odd sounds when firing your pistol, stop firing, clear the pistol and "field strip" (or disassemble) the pistol in accordance with the procedures listed in this manual. Once the barrel is removed from the slide, look down the bore. If you do not see light, there is something stuck in the bore. Do not fire the pistol again, and take the pistol to a competent gunsmith or contact the Taurus® Service department at 800-327-3776.

### **WARNING - LEAD EXPOSURE**

Discharging firearms in poorly ventilated areas, cleaning firearms or handling ammunition may result in exposure to lead and other substances known to the state of California to cause birth defects, reproductive harm and other serious physical injury. Have adequate ventilation at all times. Wash hands thoroughly after exposure with soap and cold water.

**SHOOTING OR CLEANING GUNS MAY EXPOSE YOU TO LEAD**

## FIREARMS ARE NOT ALL ALIKE

Many makes and models of firearms might LOOK nearly the same. However, they differ widely in design, operation, and in the location and function of various controls. You may access the Taurus website at [TaurusUSA.com](http://TaurusUSA.com) to view and print manuals.

## “JAMS”

SOMETIMES A CARTRIDGE OR SHELL CASE MAY BECOME “JAMMED” OR STUCK IN THE PISTOL. TO CLEAR THE JAM, (1) POINT THE MUZZLE IN A SAFE DIRECTION, (2) KEEP YOUR FINGER OFF THE TRIGGER, (3) REMOVE THE MAGAZINE, THEN (4) PULL BACK THE SLIDE AND LOCK IT TO THE REAR. THE JAMMED CARTRIDGE OR CASE CAN NOW BE REMOVED BY SHAKING OR PICKING IT OUT.



### WARNING - ANY GUN MAY FIRE IF DROPPED

If dropped or struck, the pistol may fire.



### WARNING

If dropped or struck the firearm should be inspected by a trained armorer/gunsmith for a complete function check. After the firearm was dropped or struck, mechanisms, including automatic safeties, may not function as intended resulting in accidental death or serious injury.

## OPERATING INSTRUCTIONS



1. To remove the **magazine** press the **magazine release button**, located near the **trigger guard**, with your thumb.



2. To load a **magazine** hold the bottom of the **magazine** with one hand and pull down on the **magazine loading button** using your thumb. With your other thumb insert the cartridges one at a time, pressing them down and to the rear fully under the lips of the **magazine**. Repeat until the **magazine** is loaded to magazine capacity.



3. Insert the **magazine** into the pistol until it is held by the **magazine catch**. If the **magazine** is not correctly inserted into the pistol, it might fall out when you fire the gun.



4. Hold the pistol with one hand keeping your finger away from the **trigger**. With the other hand pull the **slide** to its limit and release it, so the **slide** will go forward under **recoil spring** pressure and will insert one cartridge into the **chamber**.



5. The pistol is now ready-to-fire by pulling the **trigger**. After firing, the **slide** will recoil from gas pressure, ejecting the empty case and feed another cartridge into the **chamber** from the **magazine**. The pistol is now ready to fire again.

6. After the last round is fired, the **slide** will remain in the open position held by the **slide catch**.



7. If you want to stop shooting before firing the last cartridge of a **magazine**, (1) keep your finger off of the **trigger**, (2) point the **muzzle** in a safe direction (3) remove the **magazine** by pressing the **magazine release button** (4) pull the **slide** to the rear and lock it back and (5) look and feel the **magazine well** and **chamber** to confirm the pistol is empty. An empty firearm cannot fire.

### **WARNING**

These Taurus pistols do not have a magazine disconnect (safety). They are capable of firing with magazine removed.

### **WARNING**

If your pistol is equipped with a manual safety, the manual safety lever must be in fully engaged for the manual safety to work.

### **WARNING**

The firearm should never be operated with the manual safety lever between the "on" and "off" positions. Failure to make certain the manual safety lever is all the way "on" can result in accident, serious bodily injury or even death.

### **CAUTION**

If your pistol is equipped with a manual safety, failure to make sure that the manual safety lever is all the way in the "off" position will result in damage to the pistol.

### **WARNING - FIRING**

The slide opens and shuts quickly while firing. Keep face and hands away from the rear of the slide. Hot brass is ejected quickly and can burn you. Always wear shooting glasses, hat with brim, and hearing protection.

### **WARNING - ANY GUN MAY FIRE IF DROPPED**

If dropped or struck, the pistol may fire.

## DISASSEMBLY

### WARNING

Always wear eye protection specified for use with firearms (ANSI Z87.1+) every time you handle your firearm for cleaning and maintenance.



1. Before disassembly always (1) Keep your finger off or the **trigger**, (2) point the **muzzle** in a safe direction (3) remove the **magazine** by pressing the **magazine release button** (4) pull the **slide** to the rear and lock it back and (5) look and feel the **magazine well** and **chamber** to confirm the pistol is empty. An empty firearm cannot fire.



### WARNING

After removing the magazine, always check the chamber and make sure it is empty.



2. Hold the pistol in your hand in such a way that four fingers rest over the **slide** and your thumb rests on the rear of the **grip**. With the other hand, pull the **disassembly latch** down. Release the **disassembly latch**.

3. Pull and release the **trigger**. Push the **slide** forward 1/2" and lift the **slide** off the **grip**.



4. Release the **recoil spring assembly** from its position on the bottom of the **barrel**.

### WARNING

Please take care to prevent the forcible ejection of the slide spring assembly plate and compressed slide spring assembly.



5. Remove the **barrel** from the **slide** by pulling it to the front and down.

### WARNING

No further disassembly is recommended unless done by a qualified gunsmith.

## MAGAZINE DISASSEMBLY / ASSEMBLY



### WARNING

Use care to prevent the forcible ejection of the magazine base retainer and compressed magazine spring.

- 1) To disassemble, use a **punch** to press in on the **magazine base retainer**.
- 2) Slide the **magazine base cap** toward the front of the magazine according to picture 1 and 2.
- 3) Withdraw the **magazine base retainer** and **magazine spring** from **magazine tube**. Turn the magazine upside down until the **follower** is in the lowest position. Push the **magazine loading button** out of the follower and remove the **follower**.
- 4) Assemble in reverse order.



### WARNING

Always wear eye protection that is specified for use with firearms (ANSI Z87.1+) every time you handle your firearm for cleaning and maintenance.

## ASSEMBLY

In order to reassemble the pistol, proceed by reversing the disassembly procedure while observing the following details:



1. Insert the **barrel** in the **slide** and guide it to the rearmost position.

2. Insert the **recoil spring** assembly into the **slide** over the **barrel**, compressing the **spring** slightly to get it into position.

3. Line up the **slide** cut rail openings with the rails on the **frame**. Gently push the **slide** down on the frame and then rack the **slide** back. The **disassembly latch** will latch back in place on its own.

4. You should cycle the **slide** several times, with no **magazine** inserted and no rounds in the **chamber**, to insure that the **barrel / slide / frame** relationship is correct.



## SUPPRESSOR ADAPTER COLLAR INSTALLATION

The TX22 pistol comes with a **suppressor adapter collar** so that it can be used with a suppressor. The suppressor adapter collar features an external thread of 1/2-28 which is compatible with the majority of .22LR suppressors available on the market. Use the following directions to install the **suppressor adapter collar**.

1. Before installation always (1) keep your finger off the **trigger**, (2) point the **muzzle** in a safe direction (3) remove the **magazine** by pressing the **magazine release button** (4) pull the **slide** to the rear and lock it back and (5) look and feel that the **magazine well** and **chamber** to confirm the pistol is empty. An empty firearm cannot fire.

### WARNING

After removing the magazine, always check the chamber and make sure it is empty.

2. Prior to installing the suppressor adapter collar, the **barrel thread collar** needs to be removed from the **barrel**.
3. Point the gun away from you. Use a 3/8 inch open ended wrench to turn the **barrel thread collar** counterclockwise and loosen it from the **barrel**. Once loosened, remove it from the **barrel** using your fingers.
4. While keeping the **barrel** pointed away from you, take the **suppressor adapter collar** and start gently threading it by hand on the end of the **barrel**. Once fully threaded on the **barrel** end, use a 9/16 inch open ended wrench to firmly tighten the **suppressor adapter collar**.
5. A suppressor of your choice can now be hand tightened to the **suppressor adapter collar**. Ensure you only use a suppressor with a 1/2-28 threads. Be careful to install the suppressor properly to prevent damage to the threads on your **suppressor adapter collar**.

### NOTICE

Only use subsonic or standard velocity ammunition in your pistol when using a suppressor.

## REVERSIBLE MAGAZINE RELEASE

The TX22 pistol features a reversible magazine release. It comes configured from the factory for right handed use. To convert the magazine release to left-handed use, follow the procedure below.

1. Before proceeding always (1) keep your finger off the **trigger**, (2) point the **muzzle** in a safe direction (3) remove the **magazine** by pressing the **magazine release button** (4) pull the **slide** to the rear and lock it back and (5) look and feel the **magazine well** and **chamber** to confirm the pistol is empty. An empty firearm cannot fire.
2. Follow direction for disassembly of the pistol on page 28. The **magazine release spring** is inside the magazine well. (Fig. 1)
3. While holding the **magazine release** in place with your fingers, use a flathead screwdriver to slide the **magazine release spring** out of its groove in the **magazine release**. (Fig. 2)
4. Remove the **magazine release spring** from the **grip**.
5. Remove the **magazine release** from its slot in the **grip**.
6. Re-insert the **magazine release** reversed inside the **grip** from the left side of the **grip**.
7. Place the **magazine release spring** back into its hole in the **grip** and position the top end of it into the groove of the **magazine release**.

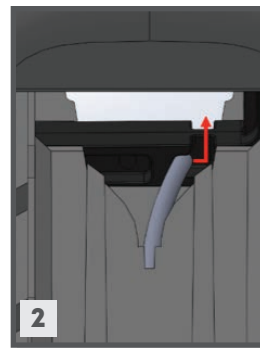
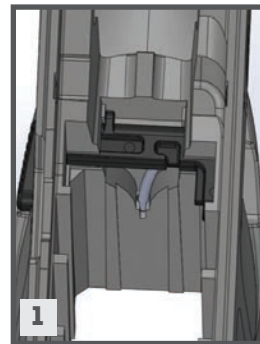

## CARE AND MAINTENANCE

Your pistol may be cleaned and lubricated under normal conditions with the disassembly steps described in pages 28-31.

In order to keep a firearm safe to use, it must be kept clean and covered with a light film of good quality oil to prevent corrosion. The barrel bore should be cleaned and left free of debris.

For normal cleaning, rub the pistol with a lightly oiled cloth. In the same way, proceed with the bore of the barrel. Excess oil should be removed.

Dust should be removed from all crevices with a small clean brush.



### WARNING

Before cleaning, (1) point the muzzle in a safe direction, (2) keep your finger off the trigger, (3) remove the magazine, then (4) pull back the slide and lock it to the rear, (5) look and feel the magazine well and chamber to confirm the pistol is empty. Never attempt to clean a loaded firearm.

## EXPLODED VIEW

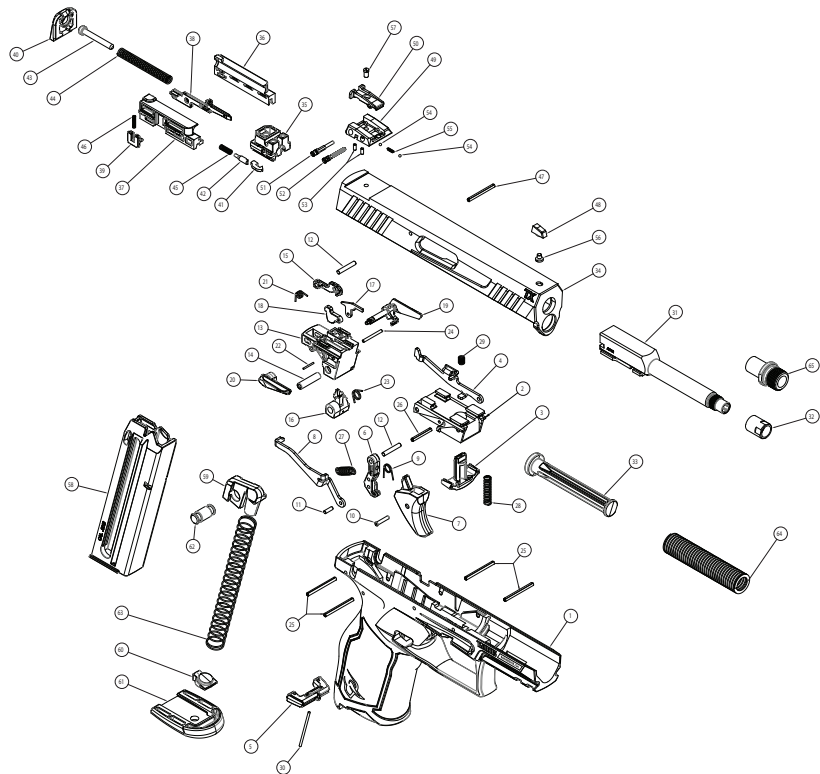

## PART LIST

- |                          |                                      |
|--------------------------|--------------------------------------|
| 1 GRIP                   | 36 HOUSING, STRIKER LEFT             |
| 2 BLOCK, CENTRAL         | 37 HOUSING, STRIKER RIGHT            |
| 3 LEVER, TAKEDOWN        | 38 STRIKER                           |
| 4 LEVER, SLIDE CATCH     | 39 BLOCK, STRIKER                    |
| 5 RELEASE, MAGAZINE      | 40 CAP, SLIDE                        |
| 6 TRIGGER                | 41 EXTRACTOR                         |
| 7 TRIGGER SHOE           | 42 PLUNGER, EXTRACTOR                |
| 8 BAR, TRIGGER           | 43 RETAINER, SLIDE CAP               |
| 9 SPRING, TRIGGER SAFETY | 44 SPRING, STRIKER                   |
| 10 PIN, TRIGGER          | 45 SPRING, EXTRACTOR                 |
| 11 PIN, DOWEL            | 46 SPRING, STRIKER BLOCK             |
| 12 PIN, DOWEL            | 47 PIN, COILED SPRING                |
| 13 HOUSING, FIRE CONTROL | 48 FRONT SIGHT                       |
| 14 BUSHING, SEAR TRIP    | 49 SIGHT BASE                        |
| 15 SEAR                  | 50 ADJUSTABLE SIGHT                  |
| 16 SEAR TRIP             | 51 VERTICAL ADJUSTMENT SIGHT SCREW   |
| 17 EJECTOR               | 52 HORIZONTAL ADJUSTMENT SIGHT SCREW |
| 18 DISCONNECTER          | 53 ADJUSTMENT SCREW PIN GUIDE        |
| 19 SAFETY, MANUAL LEFT   | 54 BALL BEARING                      |
| 20 SAFETY, MANUAL RIGHT  | 55 ADJUSTABLE SCREW SPRING           |
| 21 SPRING, SEAR          | 56 SIGHT SCREW                       |
| 22 SPRING, MANUAL SAFETY | 57 PLACEMENT SIGHT SCREW             |
| 23 SPRING, SEAR TRIP     | 58 MAGAZINE TUBE                     |
| 24 PIN, DOWEL            | 59 FOLLOWER                          |
| 25 PIN, COILED SPRING    | 60 RETAINER, MAGAZINE BASE           |
| 26 PIN, COILED SPRING    | 61 CAP, MAG BASE                     |
| 27 SPRING, TRIGGER BAR   | 62 BUTTON, MAGAZINE LOADING          |
| 28 SPRING, TAKEDOWN      | 63 SPRING, MAGAZINE                  |
| 29 SPRING, SLIDE LOCK    | 64 SPRING, RECOIL                    |
| 30 SPRING, MAG CATCH     | 65 COLLAR, SUPPRESSOR ADAPTER        |
| 31 BARREL, THREADED      |                                      |
| 32 COLLAR, BARREL THREAD |                                      |
| 33 ROD, RECOIL           |                                      |
| 34 SLIDE                 |                                      |
| 35 INSERT, IMPACT        |                                      |

## TAURUS SERVICE

Should your firearm require adjustment or repair contact our Customer Care department at 800-327-3776.

Please follow these suggestions to expedite service in the United States to return any firearm to us for adjustment or repair.

1. Federal law permits you to return your firearm to the manufacturer for service via common carriers. However, state and local firearms laws vary greatly; you should consult your local prosecuting attorney regarding any restrictive laws in your jurisdiction regarding your shipment or receipt of firearms. With the above in mind, it is strongly recommended that any firearm sent to us for repair be sent through a federally licensed dealer.

2. All firearms must be shipped to us prepaid. WE WILL NOT ACCEPT COLLECT SHIPMENTS.

3. Warranty Service: If your product is covered under the Taurus® Limited Lifetime Warranty (<https://warranty.taurususa.com>) or was manufactured prior to January 1, 2017, you must contact Taurus to receive warranty service. You may contact Taurus by calling 800-327-3776, logging onto <https://taurususa.com>, or in writing: Taurus, Attn: Warranty Service, 100 Taurus Way, Bainbridge, GA 39817. Please include a description of the claimed defect, along with your name, address, telephone number, model and serial number of your firearm, proof of purchase, and date of purchase.

4. FIREARMS MUST BE SHIPPED UNLOADED. Double check the chambers of your firearm before shipping. If firearms are sent to Taurus in a loaded condition, we are required by law to notify the Federal authorities.

5. DO NOT include telescopic sights, custom grips, holsters, or other accessories with any firearm shipped to us.

## PARTS

Firearms require periodic maintenance, inspection, adjustment and repair. If your pistol has a malfunction, be safe. Stop firing, “clear” and unload the pistol and take it to a qualified gunsmith. Before shooting it again, contact our Customer Care department if you have any questions.

If water, sand, or other foreign matter gets in your pistol, field strip it (see pages 28-29) and thoroughly clean it. Failure to keep your firearm clean and in proper working order can be dangerous.

Our Customer Care department maintains a full stock of replacement parts for current Taurus firearms. Even though most gunsmiths have the knowledge, training and ability to make the necessary repairs to your firearm, the skill and workmanship of any particular gunsmith is totally beyond our control. Should your firearm require service, return it to our Customer Care department.

Remember, unauthorized adjustments or parts replacement can void your warranty. If you choose to have someone else do the required work, the purchaser and/or installer of parts must accept full responsibility for the correct adjustment and function of the firearm.



## **TAURUS® LIMITED LIFETIME WARRANTY**

Taurus® hereby provides the following **LIMITED LIFETIME WARRANTY**, to the original purchaser of the enclosed Taurus firearm subject to the terms and conditions set forth below. **THIS IS THE ONLY WARRANTY EXTENDED BY TAURUS COVERING THIS FIREARM.**

### **What does the warranty cover and what is its duration?**

Taurus warrants to the original purchaser that the enclosed firearm was made free of defects in material, function, and workmanship. Taurus promises to remedy any defect in material, function or workmanship for the entire time that the original purchaser owns the firearm. This warranty covers the firearm's finish, grips, magazines, sights or accessories for the first year. Any claims of defect related to lasers must be directed to the manufacturer of the laser. This warranty terminates automatically upon the transfer of this firearm to any individual or entity other than the original purchaser.

### **Disclaimer and Limitation of Remedy.**

**ANY IMPLIED WARRANTIES OF MERCHANTABILITY IMPARTED BY STATE LAW WILL BE LIMITED TO ONE (1) YEAR.**

Some States do not allow limitations on how long an implied warranty lasts, so the above-limitation may not apply to you.

**ANY AND ALL INCIDENTAL AND CONSEQUENTIAL DAMAGES ARE EXPRESSLY DISCLAIMED UNDER ALL CIRCUMSTANCES.**

Some States do not allow the exclusion or limitation of incidental or consequential damages, so the above limitation or exclusion may not apply to you. This **LIMITED LIFETIME WARRANTY** gives you specific legal rights, and you may also have other rights which vary from State to State.

Taurus will not be responsible for:

1. Defects or malfunctions resulting from careless handling, unauthorized adjustments or modifications.
2. Use of defective or improper ammunition, reloaded ammunition, corrosion, neglect, abuse, ordinary wear and tear or unreasonable use.
3. Criminal misuse, negligence or use under the influence of drugs or alcohol.

### **How do you obtain warranty service?**

The warranty becomes effective only if activated by the original purchaser within thirty (30) days of the purchase date by registering online at: <https://warranty.taurususa.com> or by calling Taurus at 800-327-3776.

You must contact Taurus to receive warranty service. You may contact Taurus by calling 800-327-3776, logging onto <https://taurususa.com>, or in writing: Taurus, Attn: Warranty Service, 100 Taurus Way, Bainbridge, GA 39817. Please include a description of the claimed defect, along with your name, address, telephone number, model and serial number of your firearm, proof of purchase, and date of purchase.

## NOTES

---

---

---

---

---

---

---

---

---

---

---

---

---

---

---

---

---

---

---

---

---

---

## **IMPORTANT DO NOT DISCARD**

KEEP THIS MANUAL WITH THE FIREARM  
UPON CHANGE OF OWNERSHIP.

### **TAURUS INTERNATIONAL MANUFACTURING, INC.**

100 Taurus Way  
Bainbridge, GA 39817  
Telephone: 1-800-327-3776

**TAURUSUSA.COM**

045-0013-00 REV. 6

